

NACHI



ROBOT

Total Robot Catalog

THE FORM FOLLOWS FUNCTION

NACHI-FUJIKOSHI leveraged know-how from their hydraulic and machine tool divisions to become the first Japanese manufacturer of industrial robots in 1968.





Since then, NACHI-FUJIKOSHI has been introducing products built on its technological excellence and innovative strength to accurately respond to market demands. Currently NACHI-FUJIKOSHI has many partnerships with Automotive and General industries. Through these partnerships and the delivery of world class products NACHI-FUJIKOSHI has earned a high level of respect among these industries around the world.





From highspeed, high precision operations to lifting heavy loads used in a full range of assembly work and welding solutions. NACHI's robots are innovating production facilities with their incredible speed.

We will continue to evolve with customers to meet the challenge of the world's automation needs.



LINEUP

		HANDLING			
		MZ	MC/MR	CZ/CMZ	EC
Process and application	Field				
Number of controlled axes		5 or 6 axes	6 or 7 axes	6 axes	4 axes
Payload capacity		1 to 70kg	10 to 70kg	5 to 10kg	6 to 10kg
Maximum reach		350 to 2,102mm	1,260 to 2,050mm	927 to 1,300mm	500 to 1,000mm
Page Number		5	8	9	11
Spot welding/ Seam welding	Automotive Automotive parts		●		
Arc welding	Metalworking Agricultural machinery Construction machinery		●		
Die casting	Automotive parts	●	●	●	
Resin molding	Plastics Electric and electronics	●	●	●	
Press operation handling					
Machine loading		●	●	●	
Deburring/Polishing		●	●		
Sealing	Automotive Automotive parts Machine tools Plastics	●	●	●	
General Assembly	Pharmaceuticals and cosmetics Electric and electronics	●	●	●	●
Bolt tightening	Metalworking Chemistry	●	●	●	●
Picking, aligning, packaging	Medical equipment Foodstuffs Agricultural machinery	●	●	●	●
Shipping and receiving (palletizing)	Construction machinery	●	●	●	
Measuring, inspection, testing		●	●	●	●
Material handling		●	●	●	●
Glass substrate loading	Electric and electronics				

HANDLING		PALLETIZING		WELDING	CLEAN-ROOM
EZ	MC and SC Heavy Loader	LP/MC	SRA-H/SRA	ST-C	
					
4 axes	6 axes	4 or 5 or 6 axes	6 axes	6 axes	
3kg	280 to 1000kg	130 to 500kg	100 to 300kg	133 to 210kg	
450 to 550mm	2,771 to 3,972mm	2,771 to 3,756mm	1,634 to 3,383mm	2,654 to 2,674mm	
12	13	15	17	19	
	●		●		
			●		
	●		●		
	●		●		
	●		●		
			●		
			●		
●			●		
●			●		
●			●		
	●	●	●		
●	●				
●	●	●	●		
				●	

Handling robot

- Machine loading
- Picking
- Loading
- Assembly
- Palletizing
- Deburring/Polishing
- Sealing



High speed/High precision compact robot

MZ SERIES

High speed/High precision compact robot available in protection against dust and water, multiple installation orientations.

Large selection of payload from 1 to 70kg.

The internal wire routing for the tooling significantly increases cabling reliability so that operations in a narrow space are possible.

Wide operating range improves productivity and also high spec/performance applications such as vision sensor are available.

Meets various automation needs.

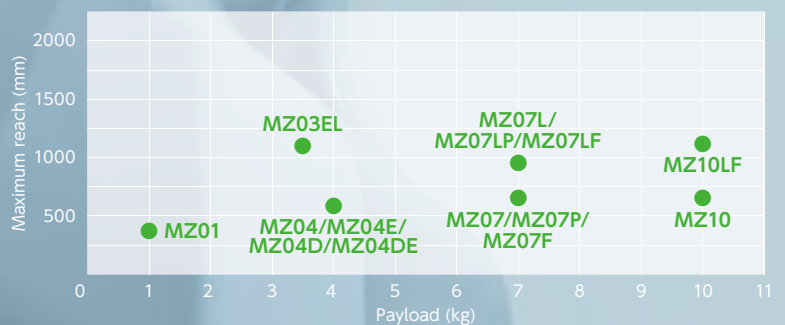



MZ01

High speed and high precision
1kg compact robot.

- Number of controlled axes 6 axes
- Payload 1kg
- Maximum reach 350mm



MZ03EL

Maximum reach 1,102mm with 3.5kg payload.
Compact long arm robot.

- Number of controlled axes 6 axes
- Payload 3.5kg
- Maximum reach 1,102mm

MZ04

Downsizes facility with light-weight
compact body.
Sophisticated and flowing form.
Smooth surface design, easy
to clean covers.

- Number of controlled axes 6 axes
- Payload 4kg
- Maximum reach 541mm



MZ07/MZ07L

Meets various automation
needs with various options.

- Number of controlled axes 5 or 6 axes
- Payload 7kg
- Maximum reach MZ07 : 723mm
MZ07L: 912mm



MZ07F/MZ07LF

Achieves even higher speed and precision
while MZ07 series features, lightweight,
compact body, and hollow wrist are maintained.

- Number of controlled axes 6 axes
- Payload 7kg
- Maximum reach MZ07F : 723mm
MZ07LF: 912mm



MZ10

10 kg payload with
the same dimensions
and workspace as MZ07.

- Number of controlled axes 6 axes
- Payload 10kg
- Maximum reach 723mm



MZ10LF

Achieves payload improvement,
longer reach, and higher speed and
precision while MZ07 series features,
lightweight, compact body,
and hollow wrist are maintained.

- Number of controlled axes 6 axes
- Payload 10kg
- Maximum reach 1,202mm

MZ12/MZ12H

IP 67 equivalent (dust-proof, moisture-resistant), with rust proof/coolant resistant paint. Powerful and slim multi purpose compact robot.

- Number of controlled axes 6 axes
- Payload 12kg
- Maximum reach 1,454mm



MZ25

Supports various applications with large operating range and powerful wrist.

- Number of controlled axes 6 axes
- Payload 25kg
- Maximum reach 1,882mm



NEW MZ35F/50F/70F

Space-saving with lightweight/slim body. Adopts a hollow wrist structure to avoid interference with peripheral equipment. Flexible operation even in narrow spaces.

- Number of controlled axes 6 axes
- Payload 35 to 70kg
- Maximum reach 2,102mm



Hollow wrist



Rack storage

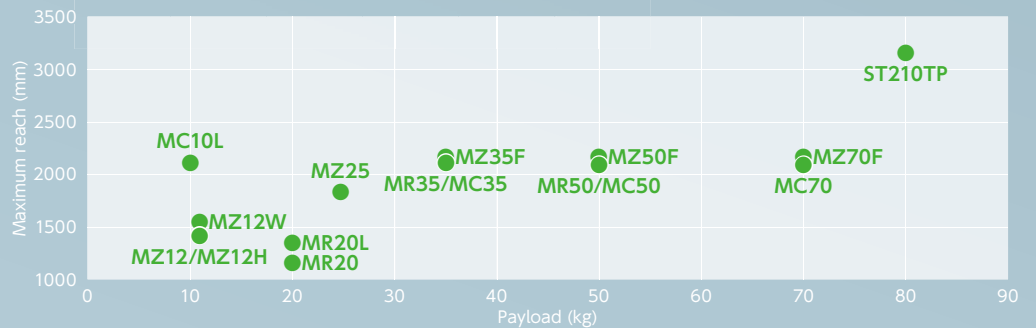

Picking



Deburring/Polishing



Machine loading



Assembly

NEW
MZ12W

Space-saving/wall mount type robot.
Large wrist torque allows for use with large hands.
Ideal for storing racks in the board transport process, etc.
The hand can be inserted in various directions with a free control posture that takes advantage of the vertical multi-joint structure.

- Number of controlled axes 6 axes
- Payload 12kg
- Maximum reach 1,564mm



Powerful and compact multi-purpose robot

MC SERIES

High dust-proof and moisture-resistant, combined with outstanding performance and a full range of functions to handle a variety of applications make these robots ideally suited for a variety of production environments.

- Number of controlled axes 6 axes
- Payload 10 to 70kg
- Maximum reach 2,019 to 2,050mm



Flexible motion "Arm" robot with 7-axes

MIR SERIES

With a programmable pose, this 7-axis arm design can handle complex motions to flexibly work in processes that other robots cannot. The compact robot arm greatly reduces the amount of space needed for installations.

- Number of controlled axes 7 axes
- Payload 20 to 50kg
- Maximum reach 1,260 to 2,050mm



Press operation handling robot

ST210TP

High rigid design with vibration dampening gives this robot its great speed.
This newly developed specialized press arm attachment gives this robot a much larger reach that can be used for a press pitch of up to eight meters. Moves parts horizontally at high speed.

- Number of controlled axes 7 axes
- Payload 80kg
- Maximum reach 3,106mm



Handling/Transfer



Press-tending

Collaborative robot

- Picking
- Assembling support
- Assembly
- Machine loading



People-friendly collaborative robot

CZ CMZ

NACHI's collaborative robots CZ10 and CMZ05 are fully loaded with human-friendly functions. Safety fences are not required and makes it easier to install a robot with various applications.

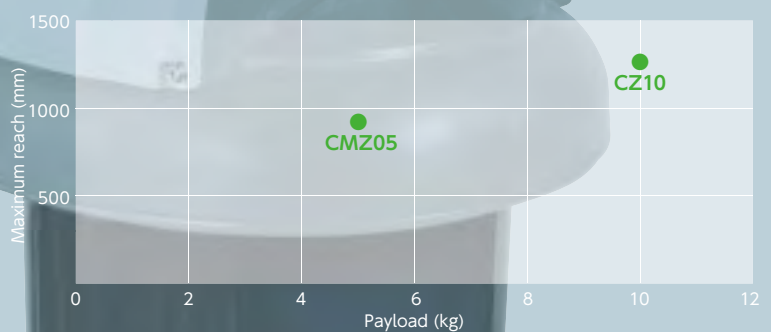



NEW
CMZ05

Collaborative robots with high rigidity and safety design that complies with safety standards ISO10218-1/13849-1/TS15066, achieving both high-speed/high-precision performance and safety. Hand wiring is routed through the hollow wrist to avoid interference with peripheral equipment. It can operate flexibly even in narrow spaces and contributes to smarter lines.

- Number of controlled axes 6 axes
- Payload 5kg
- Maximum reach 927mm



CZ10

People-friendly design

People-friendly design with rounded arms and gap between joints.

- Number of controlled axes 6 axes
- Payload 10kg
- Maximum reach 1,300mm



Awarded the certification by certification organization.
Safety certification :
Conforming to ISO 10218-1
Conforming to TS 15066



Picking



Assembling support



Assembly



Machine loading

SCARA robot

SCARA robot

EC SERIES

The EC06 series are simple structure robots with high-speed & high precision. They meet the needs for applications such as assembling & handling.

We have a lineup of a wide range of maximum reach from 500 to 1,000 mm.

Furthermore, the hollow structure at the tip of the wrist simplifies piping and wiring from the robot body to various tools.



EC06

- Number of controlled axes 4 axes
- Payload 6kg
- Maximum reach 500 to 700mm

NEW EC10

The lineup has 4 types of robots with different maximum reach and vertical stroke.

The use of a hollow shaft simplifies wiring.

Avoids interference with peripheral equipment and realizes a more compact equipment layout.



- Number of controlled axes 4 axes
- Payload 10kg
- Maximum reach 800 to 1,000mm



WING SLICER Type robot

EZ SERIES

The EZ series robots are high-speed, horizontally articulated & equipped with a space-saving vertical first axis.

They have a high speed, high accuracy structure that is excellent for applications such as assembly and handling. Cable routing is simplified by the hollow construction through the end of the wrist, capable of routing cables through.

The internal wire routing for the tooling significantly increases cabling reliability.

The Wing Slicer family has multiple models with varying reach and payload to support a variety of equipment operations.

**EZ03**

- Number of controlled axes 4 axes
- Payload 3kg
- Maximum reach 450 to 550mm



Packing



Inspection



Assembling

Super heavy loader robot

Automobiles' body handling etc.

With high wrist torque and large operating envelope, these robots are opening up a new era of heavy loading robots.



Super heavy loader robot

MC HEAVY LOADER SERIES

Tool cables and hoses routed inside the hollow arm provides excellent life.



MC1000DL

- Number of controlled axes 6 axes
- Payload 1,000kg
- Maximum reach 3,972mm



MC600

- Number of controlled axes 6 axes
- Payload 600kg
- Maximum reach 2,890mm



SC700DL

- Number of controlled axes 6 axes
- Payload 700kg
- Maximum reach 3,972mm

SC HEAVY LOADER

The SC heavy loader robots, with huge load capacity and reach, are excellent for jobs that require heavy lifting. Their large vertical stroke allows more flexible production lines by replacing conventional specialized machinery, such as auto body lifters, with robots.

Palletizing robot

High-speed palletizing robot
Heavy loader palletizing robot

NACHI's palletizing robots help with intricate palletizing of boxes, crates and sacks for shipping and receiving processes.

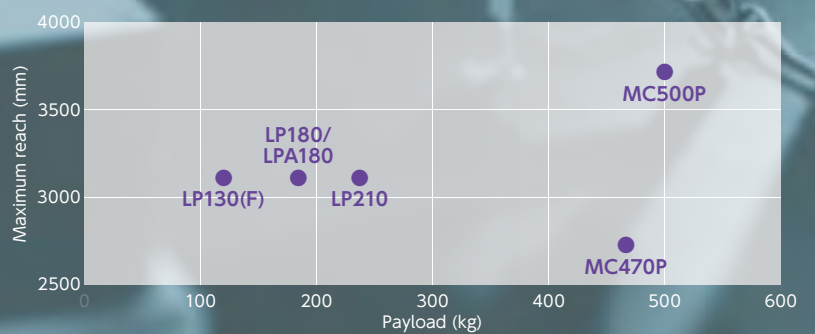
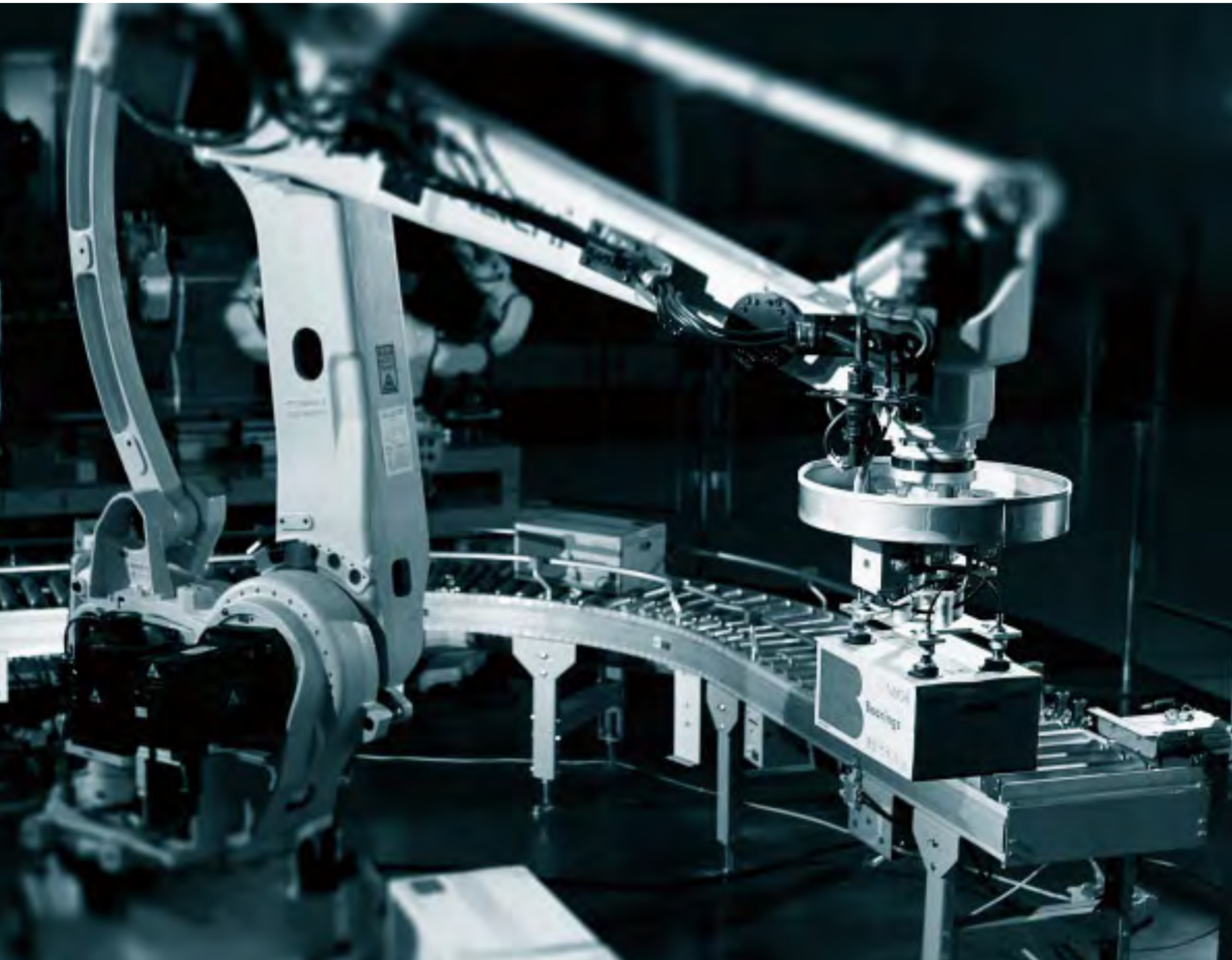

High-speed palletizing robot

LP SERIES

The LP series of specialized palletizing robots do large movements quickly. They can stack products, such as cardboard boxes, or products in bags, such as foodstuffs or chemicals, onto pallets at high speeds. Loaded with palletizing functions, they can handle a wide variety of stacking patterns.

■ Number of controlled axes	4 axes
■ Payload	130 to 210kg
■ Maximum reach	3,210mm



Heavy loader palletizing robot

MC SERIES

This robot has enough lifting power to handle jobs of loading and stacking beverages, bricks, plastic resins, concrete and other heavy goods.

■ Number of controlled axes	5 or 6 axes
■ Payload	470 to 500kg
■ Maximum reach	2,771 to 3,756mm



Palletizing

Spot welding robot

Welding robots are the central element of automobile production, especially the auto body welding lines. The performance, functionality, and reliability of the NACHI lineup of spot welding robots are supporting the world of manufacturing.

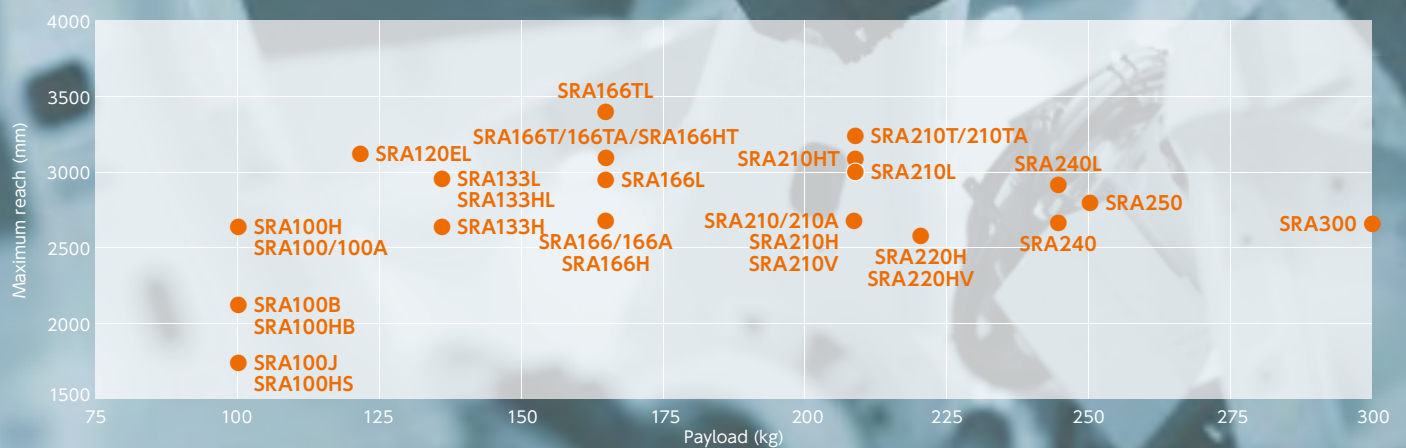

Spot welding robot with built-in cables

SRA-H SERIES

The next generation of hollow arm spot welding robots. Cables and hoses for the welding gun are fully enclosed to increase cable reliability and improve rate of operation. Provides a cleaner profile for installing directly in the assembly line and improves operational accuracy of offline programming, including welding cables. This hollow arm model is now available in shelf mount version for 166 kg & 210 kg payloads.

■ Number of controlled axes	6 axes
■ Payload	100 to 220kg
■ Maximum reach	1,634 to 2,951mm



Ultra-fast spot welding robot

SRA SERIES

The Ultimate Spot Welding Robot. Using higher speeds and vibration damping properties, we greatly improved productivity by shortening cycle times 30% (compared to our previous models) improvements were made in three areas, weight reduction, higher rigidity, and faster controls.

The compact design allows for high density installation layouts and maintenance is streamlined making periodic inspections and parts replacement easy to do.

The lighter weight and the latest in motor drive controls have reduced power consumption by 15% over previous models reducing environmental impact.

A new long arm type with a payload capacity of 210/240 kg is added to the lineup.

In addition, the payload can be selected up to a maximum of 300 kg, meeting further needs on site.

■ Number of controlled axes	6 axes
■ Payload	100 to 300kg
■ Maximum reach	1,634 to 3,383mm

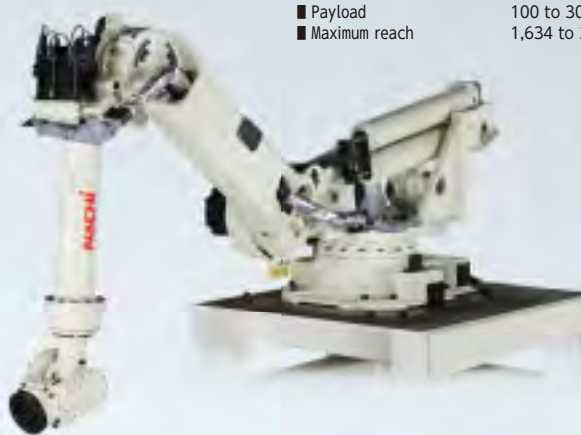

Spot welding

Clean-room robot

Clean-room loading

Our series of clean-room robots suppress the dust created by arm movements and are designed to be used in clean rooms. These high-performance loading robots support the heart of the flat panel display production process.

ST-C SERIES



- Number of controlled axes 6 axes
- Payload 133 to 210kg
- Maximum reach 2,654 to 2,674mm

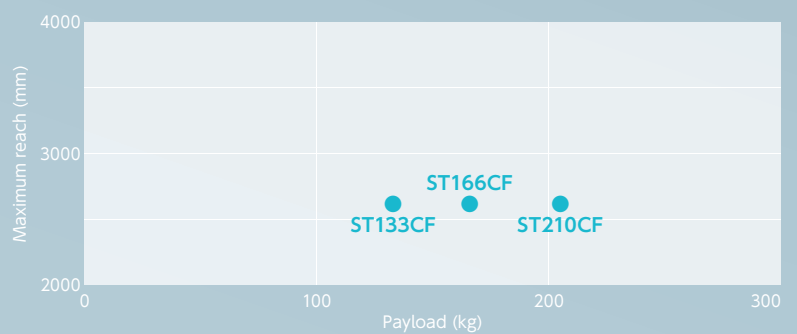

OPTIONS



FLEXhand

Servo hand controlled as an additional axis by the robot controller. Capable of handling many shapes without changing the hand. This is an excellent tool for small-lot multiple item production.



Compact vision sensor NVsmart

Integrated A1:D58, lighting, and image processing equipment to save space and wiring. Processing speed is also improved 2.5 times compared with the conventional one. It can be configured and monitored on teach pendant and also supports additional control of external cameras. It is possible to recognize mixed workpieces, and supports character recognition, barcode recognition, OCR.



Force sensor

This function controls the robot by accurately detecting the applied force. This powerful tool makes it possible for robots to do delicate operations at high speed, such as following, pushing, loading (press fitting), detecting position and phase during assembly and production processes.



Position posture recognition

Posture can be correctly recognized even when various workpieces are mixed.

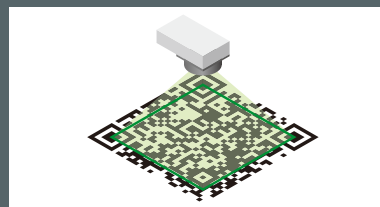

Barcode recognition

Recognizes barcodes/QR codes without additional equipment such as QR Code Scanners.

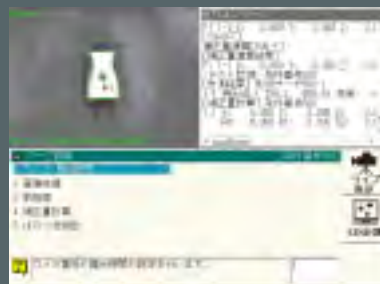

Cooperation with teach pendant

Vision setting and monitoring can be set through robot teach pendant.

NVsmart System Configuration Diagram

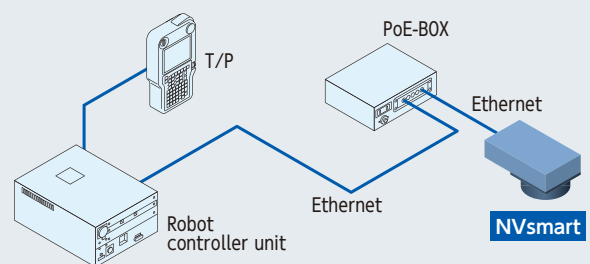

Packaged Product

Connector insertion application

The new visual control application enables high-speed and high-precision insertion of FPC and FFC for various applications such as smartphones and in-vehicle displays.



High-precision and high-speed operation

- Our original visual control enables high-speed, high-precision insertion into the connector.
- Performs real-time scanning and repeats measurements and movements until the target point is reached. Follow-up correction is possible even if the target point deviates during movement.
- Since a force sensor is not used, connector insertion time is greatly reduced.

Equipped with traceability function as standard*

- Visual inspection results at the time of insertion and completion are saved as image data.
 - Equipped with a QR code reader function as standard, it is possible to manage and record inspection results and link to image data.
- * USB port expansion cable (optional) and USB flash drive (Customer Prepared) are required.



Grip



Insert



Inspection

WEB VIDEO

You can watch videos of use cases of connector insertion application on smartphones and mobile phones.



System standard kit

- Standard kit for building automated equipment using robots with a payload of 5 to 12 kg.
- Systemize by combining necessary equipment.
- Pre-installed operating screen, I/O settings, and standard robot program.
- Easy installation and relocation with Plug & Play.
- Movable with a hand lifter, so you can use it when and where you want.

System standard kit components

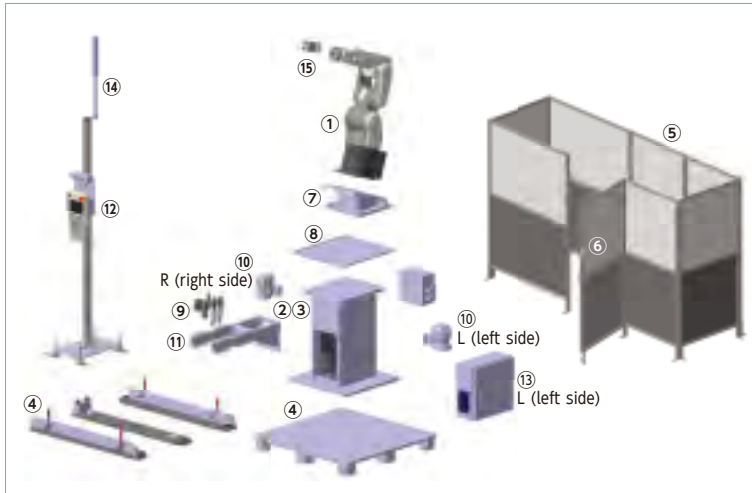

① Robot	⑨ Air pressure conditioning unit
② Robot riser	⑩ Safety laser scanner
③ Robot clamping parts	⑪ Pallet installation arm
④ Movable installation unit (movable side module/fixed base)	⑫ Teach pendant holder stand
⑤ Safety fence	⑬ Connection box for system controller (installed on the left side in this diagram)/Breaker box
⑥ Safety fence option	⑭ Signal tower
⑦ Tilted installation stand	⑮ Robot gripper (MZ standard gripper or small flex gripper)
⑧ Oil pan	

Screw tightening unit STU5

- Automatically correct the relative positions of screws and screw holes in three dimensions using a 3D vision device.
- Automatically corrects the tilt of the screw relative to the screw hole using cameras from two directions.
- Reduces failures related to screw tightening work such as missing screws, diagonal insertion of screws, and floating screws.
- Screw tightening status traceability function and automatic bit exchange device available as options.

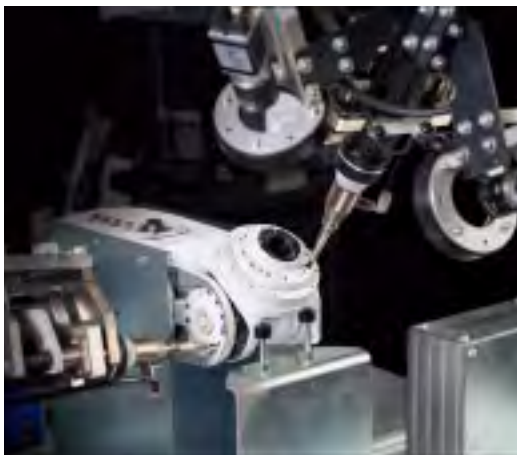

CONTROLLERS

Introducing the intelligent robot controller based on Windows.
Robots and additional axis are easy to operate by using the teach pendant. Vision and force sensors, as well as networks, are managed in one place.



Item	Specifications	
Basic specifications for controller		
Controllable axes	6	
Maximum controllable axes	6	8
Volume	6.0L	12.4L
Weight	5kg	8.9kg
External dimensions (mm)	270(W)×270(D)×82.9(H) Exclude Fan Motor, Switch, Connector, etc.	310(W)×250(D)×160(H) Exclude rubber feet, switches/connectors
Position reader	Absolute encoder	
Programming system	Teaching playback	
Operating panel	-	Mode switch (teach/playback), emergency stop button
Cables between robot and control panel	2m, 5m, 10m, 15m, 20m (connector type) extension (total) 25m	
Additional slot	PCIex1 slots	PCIex2 slots
PLC function	Software PLC ISaGRAF 6	
Protection class	IP20 equivalent	
Power supply	Single phase 200–230VAC, 50/60Hz, D grounding, max. leakage 10mA	
Ambient temperature/humidity	0 to 45° C (50/60Hz) 20 to 85% (No dew or frost allowed)	
Safety function	Safety sequence PLd, category 3 (ISO 13849 -1: 2015)	
Overseas compliance	Europe: CE, Korea: KCs, North America UL/CSA	
Controller options		
Power voltage converter	Single phase 100 VAC, 50/60 Hz	
External storage	USB Flash Drive (1 GB)	
Additional axes	-	Additional 2 axes
Fieldbus	EtherNet/IP, EtherCAT, Profinet, CC-Link and others. Maximum 2 channels can be installed.	EtherNet/IP, EtherCAT, Profinet, CC-Link and others. Maximum 4 channels can be installed.
Additional input/output signals	Additional I/O board: 32 points/32 points	Additional compact I/O board: Maximum 16/16 point, Additional I/O board: Maximum 64/64 point
Output signals	Additional I/O board: Transistor output	Additional compact I/O board : Relay contact output, Additional I/O board: Transistor output
Analog input/output	-	
Vision sensor	NVsmart	
Conveyor tracking function	Conveyor tracking control	
Palletize function	Palletizing control function	
Robot language	JIS B 8439 SLIM compliant	
Robot monitoring function	-	Position/speed monitoring function: PLd (Category 3 compatible)

FD controller FD18	FD controller FD20
---------------------------	---------------------------



Item	Specifications	
Basic specifications for controller		
Controllable axes	6	
Maximum controllable axes	8	
External dimensions (mm)	300(W)×600(D)×530(H) Excluded Casters (50mm), Switches/connectors	580(W)×532(D)×490(H) Excluded Casters (50mm), Switches/connectors
Position reader	Absolute encoder	
Programming system	Teaching playback	
Operating panel	Mode switch (teach/playback), emergency stop button	
Cables between robot and control panel	2m, 5m, 10m, 15m, 20m, 25m (connector type) extension (total) 25m	5m, 10m, 15m, 20m, 25m (connector type)
User interface	User panel : On back	
Additional slot	PCI×2 slots	PCI×3 slots
PLC function	Software PLC IEC1131-3 compliant	
Protection class	IP54 equivalent	
Power supply	3φ 200–230VAC, 50/60Hz, D grounding, breaker 40A, max. leakage 100mA	
Ambient temperature/humidity	0 to 45° C (50/60Hz) 20 to 85% (No dew or frost allowed)	
Safety function	Safety sequence :PLe (category 4)	
Controller options		
Overseas compliance	North America: CSA/UL, Europe: CE	
Power voltage converter	380/400/420/440/460/480VAC (3φ 50/60Hz) D grounding, breaker 30A, max. leakage 100mA Transformer BOX size: W300×D600×H430 Casters (90mm), Switches/connectors not included Size when controller and transformer BOX are connected: W300×D600×H960 Casters (90mm), Switches/connectors not included	380/400/420/440/460/480VAC (3φ 50/60Hz) D grounding, breaker 30A, max. leakage 100mA Built-in transformer
External storage	USB Flash Drive (1 GB)	
Additional axes	Gun, slider, jig and gripper	
Fieldbus	DeviceNet, CC-Link, CC-Link IE Field and others. Maximum 4 channels can be installed.	
Additional input/output signals	Additional compact I/O board: Maximum 14/10 point, Additional I/O board: Maximum 32/32 point	Additional compact I/O board: Maximum 14/10 point, Additional I/O board: Maximum 64/64 point
Output signals	Relay contact specifications cations 32 point	Relay contact specifications cations 32 point
Analog input/output	2/4 point	
Vision sensor	NVsmart	
Conveyor tracking function	Conveyor tracking control	
Palletize function	Palletize and de-palletize	
Robot language	JIS SLIM compliant	
Robot monitoring function	Position/speed monitoring function:PLd (category 3)	

CONTROLLERS

Teach pendant

A small and lightweight teach pendant.

Equipped with a high-definition touch panel and has a wide range of optional functions.



Item	Specification	
	CFDq	CFDs/FD18/FD20
Display	5.7 inch VGA color LCD touch panel	
Language	Japanese (Kanji, Hiragana, Katakana, Alphanumeric) English/Chinese/Korean option*: German/Italian/Spanish/Taiwanese	
Enable SW	One-handed enable switch, three positions, (left hand side)	
Operation function	Axis operation key, value input key, selection/function key, motors on key, emergency stop	
External storage interface	USB port	
Cable length	8m, 15m, 20m, 25m, 30m (connector type)	
Protection class	IP65 equivalent	
External dimensions (mm)	163(W)×74.5(D)×353(H)	
Weight	0.9kg	

* Included in the standard specification for CFDs controller

Option **Graphic user interface Flex Gui**

Freely customize the screen of the teach pendant. It can be used as an operating panel for the entire system including peripheral devices.

FlexGui

- Creation of operating monitor screens tailored to applicable processes and applications.
- Intuitive system operation with touch panel
- The entire system can be controlled by using the software PLC function.
- Abolishing the independent system controller, contributing to space savings and cost reductions.

FlexGui Remote

- Connect a computer to the robot controller
- Remote display and operation of teach pendant (FlexGui) screen

FlexGui Toolbox

- Easily create screens with the editing tool "FlexGui Toolbox"
- Prepare a wide variety of parts (items that make up the screen)



NEW
Tablet TP

Tablet TP is a new type of teaching device that uses a commercially available tablet attached to a special holder. The large, easy-to-read screen provides unprecedented operability.



Item	Specification
	TBHLDR-0000/TBHLDR-0010
Compatible robot Controloer model	MZ03EL/MZ04/MZ07/MZ10 series/CFDs-0000* ¹ , MZ-F series/CFDs-0000F, MZ01 series/CFDs-0040* ¹ , MZ12 series/CFDs-3000, CMZ series/CFDs-0000C
Compatible tablet specifications * ²	Screen size: 10-13 inches, thickness: 10mm or less, weight: 1.1kg or less (see standard specifications for details)
Number of controlled axes	Standard 6 axes (robot axes only) *External axes are not supported
Teaching method	Teaching playback
Number of program selections	9,999 species
Operating switch	Emergency stop button, +/- button, Select button
Protection class	IP54 equivalent (excluding tablet PC and USB Type C cable)
Power supply	DC24V±10% Supplied from TP cable (FD19TP-D04M)
Ambient temperature	0 to 40°C
Transport/storage temperature	-25 to 55°C (up to 70°C allowed within one day)
Ambient humidity	20-85% (No dew, nor frost allowed)
Elevation	At 1000m or lower sea level
External dimensions (mm)	224.8(W)×225.6(D)×83.2(H) *Excluding tablet and TP cable.
Standard mass	775g *Excluding tablet and TP cable.

*1: Even in the case of CFDs controller, the following robots are not supported, please note. EC series (CFDs-0040/CFDs-2040F), EZ series (CFDs-0000)
 *2: This may not apply depending on the shape of the tablet. In addition, the weight specifications of compatible tablet is a reference value. Please note that we do not guarantee that the product will not be destroyed or malfunction due to the fall impact.

Easy programming with Drag&Drop

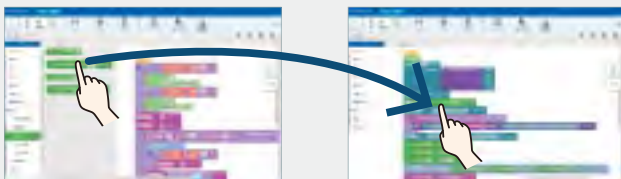

Large screen that is easy to see and press

Large, easy-to-press button

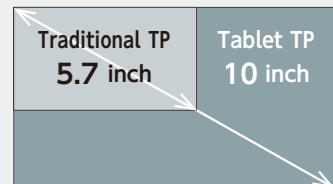

*Tablets will be provided by the customer.

Intuitive operability like a smartphone

Tap the icon

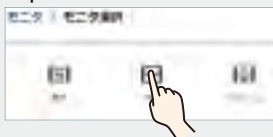

Manipulate graphs directly

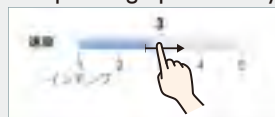

Easy-to-understand guides and tutorials

Guide function

If you touch the part you want to see the explanation, the message will be displayed.

Tutorial function

A video with audio guide explains basic usage.

Customize the way you hold it

By replacing the holder parts, you can freely change between holding it in both hands and holding it in your left hand. Additionally, the grip angle can be changed according to the operator's preference, allowing a comfortable holding position and reducing fatigue during long hours of teaching work.



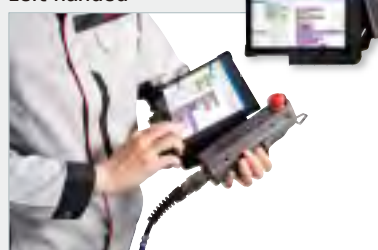



Left handed



Both hand

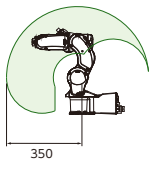
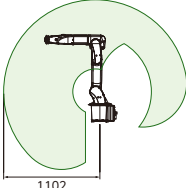
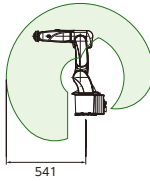
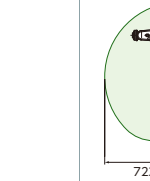
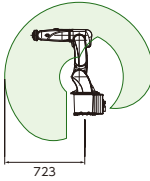
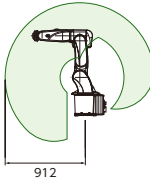

LIST OF SPECIFICATIONS

		MZ01	MZ03EL	MZ04 (MZ04D)	MZ04E (MZ04DE)	MZ07 (MZ07P)	MZ07L (MZ07LP)	
								
No. of axes		6				6(5)*1		
Max. working envelope	Arm	J1 Swivel 1	±170°					
		J2 Horizontal	-90~+85°	-135~+80°	-145~+90°		-135~+80°	
		J7 Swivel 2	-					
	Wrist	J3 Vertical	-111~+175°	-155~+270°	-125~+280°		-136~+270°	-139~+270°
		J4*1 Rotation 2	±145°	±190°		±190° (-)		
		J5 Bend	±125°	±120°				
		±360°						
Max. speed	Arm	J1 Swivel 1	320° /s	300° /s	480° /s	200° /s	450° /s	300° /s
		J2 Horizontal	320° /s	230° /s	460° /s	150° /s	380° /s	280° /s
		J7 Swivel 2	-					
	Wrist	J3 Vertical	375° /s	360° /s	520° /s	190° /s	520° /s	360° /s
		J4*1 Rotation 2	600° /s	550° /s	560° /s		550° /s (-)	
		J5 Bend	600° /s	550° /s	560° /s		550° /s	
		600° /s		1,000° /s		900° /s		
Maximum load	Wrist	1kg	3.5kg	4kg		7kg		
	Load capacity on forearm	0.25kg	-					
Allowable static load torque for wrist	J4*1 Rotation 2	0.9N·m	6N·m	8.86N·m		16.6N·m (-)		
	J5 Bend	0.9N·m	6N·m	8.86N·m		16.6N·m		
	J6 Rotation 1	0.78N·m	2.9N·m	4.9N·m		9.4N·m		
Allowable moment of inertia for wrist	J4*1 Rotation 2	0.008kg·m ²	0.12kg·m ²	0.2kg·m ²		0.47kg·m ² (-)		
	J5 Bend	0.008kg·m ²	0.12kg·m ²	0.2kg·m ²		0.47kg·m ²		
	J6 Rotation 1	0.006kg·m ²	0.03kg·m ²	0.07kg·m ²		0.15kg·m ²		
Maximum reach	350mm		1,102mm	541mm		723mm	912mm	
Pose repeatability	±0.02mm		±0.03mm	±0.02mm		±0.02mm	±0.03mm	
Ambient temperature*2/ humidity	0 to 40°C/20 to 85% RH (without condensation)		0 to 45°C/20 to 85% RH (without condensation)					
Vibration	0.5 G or less							
Installation	Floor, wall, inverted, tilted mount				Floor, inverted mount	Floor, wall, inverted, tilted mount		
Ingress protection	IP40 equivalent	IP67 equivalent	IP40 equivalent*3		IP67 equivalent			
Weight	10kg*4	39kg	26kg*4	25kg*4	36kg*4	38kg*4		
Power consumption	0.4kVA							
Supported Controller	CFD/CFDs/CFDq	CFD/CFDs	CFD/CFDs	CFD/CFDs	CFD/CFDs	CFD/CFDs	CFD/CFDs	
Working envelope								

* Maximum speeds are maximum values, they will vary depending on the wrist load conditions and operating program.
 *1: For the 5-axis specifications (MZ07P and MZ07LP), the configuration does not have the J4 axis. *2: Using at 1,000 m or lower sea level. Ambient temperature has limitations when allowable altitude is exceeded.
 *3: MZ04 and MZ04E have IP40 equivalence. MZ04D and MZ04DE have IP67 (dust proof and water proof) equivalence.
 4: Wall mount Rear Connection Type: +4kg (MZ04 Series), +6kg (MZ07* Series) / Bottom Connection Type: +6kg (MZ04* Series), +8kg (MZ07* Series), +2.5kg (MZ01)
 *5: Operating range is limited when mounted on a wall or tilted. (Example: #1-axis operating range is ±30° for wall mount)

	MZ10	MZ07F	MZ07LF	MZ10LF	MZ12	MZ12H
						
	6			6		
	±170°			±170°		
	-135~+80°		-135~+80°			-160~+90°
	-			-		
	-136~+270°	-136~+270°	-139~+270°	-136~+270°		-147~+210°
	±190°			±190°		
	±120°		±120°			±140°
	±360°			±360°		
	300° /s	450° /s		300° /s		260° /s
	250° /s	380° /s	280° /s	200° /s		230° /s
	-			-		
	360° /s	520° /s	360° /s	330° /s		260° /s
	450° /s		550° /s			470° /s
	340° /s		550° /s			470° /s
	700° /s		1000° /s	740° /s	700° /s	740° /s
	10kg		7kg	10kg		12kg
	-			-		
	17.9N·m		16.9N·m	20N·m	25N·m	26.5N·m
	17.9N·m		16.9N·m	20N·m	25N·m	26.5N·m
	10.4N·m		9.4N·m	10.4N·m	9.8N·m	12N·m
	0.47kg·m ²		0.49kg·m ²	0.6kg·m ²	0.7kg·m ²	0.9kg·m ²
	0.47kg·m ²		0.49kg·m ²	0.6kg·m ²	0.7kg·m ²	0.9kg·m ²
	0.15kg·m ²		0.15kg·m ²	0.2kg·m ²	0.2kg·m ²	0.3kg·m ²
	723mm	723mm	912mm	1,202mm		1,454mm
	±0.03mm	±0.015mm	±0.02mm	±0.025mm		±0.04mm
	0 to 45°C/20 to 85% RH (without condensation)					
	0.5 G or less					
	Floor, inverted mount	Floor, wall, inverted, tilted mount*5		Floor, inverted mount	Floor, inverted, tilted mount	
	IP67 equivalent					
	36kg	41kg	43kg	55kg	150kg	155kg
	0.4kVA	0.7kVA	0.8kVA	0.8kVA	1.8kVA	
	CFD/CFDs	CFDs/CFDq	CFDs/CFDq	CFDs/CFDq	CFD/CFDs	CFD/CFDs
						
	723	723	912	1202	1454	1454

1 [N·m] = 1/9.8 [kgf·m]

LIST OF SPECIFICATIONS

		MZ12W	MZ25	MZ35F	MZ50F	MZ70F	
							
No. of axes		6	6		6		
Max. working envelope	Arm	J1 Swivel 1	±95°	±170°		±180°	
		J2 Horizontal	+180~-70°	-150~+105°		-135~+80°	
		J7 Swivel 2	-	-		-	
	Wrist	J3 Vertical	+210°~-147°	-161~+289°		-143.5~+260°	
		J4 Rotation 2	±190°	±190°		±190°	
		J5 Bend	±135°	±145°		±145°	
Max. speed	Arm	J6 Rotation 1	±360°	±360°		±360°	
		J1 Swivel 1	260° /s	210° /s	188° /s	185° /s	180° /s
		J2 Horizontal	230° /s	185° /s	180° /s		145° /s
	Wrist	J7 Swivel 2	-	-		-	
		J3 Vertical	260° /s	270° /s	195° /s	185° /s	170° /s
		J4*1 Rotation 2	470° /s	420° /s	280° /s	260° /s	240° /s
Maximum load	J5 Bend	280° /s	420° /s	310° /s	260° /s	240° /s	
	J6 Rotation 1	620° /s	672° /s	420° /s	370° /s	350° /s	
Allowable static load torque for wrist	Wrist	12kg	25kg	35kg	50kg	70kg	
	Load capacity on forearm*2	-	-	-	-	-	
Allowable moment of inertia for wrist	J4 Rotation 2	55N·m	52N·m	165N·m	216N·m	309N·m	
	J5 Bend	55N·m	52N·m	165N·m	216N·m	309N·m	
	J6 Rotation 1	50N·m	32N·m	102N·m	147N·m	170N·m	
Maximum reach	J4 Rotation 2	3kg·m ²	2.4kg·m ²	16kg·m ²	30kg·m ²	30kg·m ²	
	J5 Bend	3kg·m ²	2.4kg·m ²	16kg·m ²	30kg·m ²	30kg·m ²	
	J6 Rotation 1	2.6kg·m ²	1.3kg·m ²	5kg·m ²	12kg·m ²	12kg·m ²	
Pose repeatability		1,564mm	1,882mm		2,102mm		
Ambient temperature*3/ humidity		±0.04mm	±0.05mm		±0.06mm		
Vibration		0 to 45°C/20 to 85% RH (without condensation)					
Installation		0.5 G or less					
Ingress protection		Floor, inverted, tilted mount		Floor, inverted mount			
Weight		IP67 equivalent		IP67 equivalent			
Power consumption		195kg	250kg	608kg			
Supported Controller		2.0kVA	2.55kVA	2.17kVA			
Working envelope		CFDs	FD11/FD18	FD18			
							
		1564	1882		2102		

* Maximum speeds are maximum values, they will vary depending on the wrist load conditions and operating program.

*1: For the 5-axis specifications (MZ07P and MZ07LP), the configuration does not have the J4 axis.



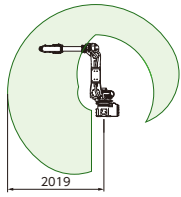
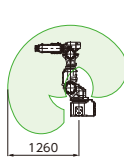
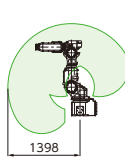

*2: This value changes by placement and load conditions of a wrist.

*3: Using at 1,000 m or lower sea level. Ambient temperature has limitations when allowable altitude is exceeded.

	MC10L	MC35	MC50	MC70	MR20	MR20L
						
	6		6		7	
	±180°		±165°		±180°	
	-145~+60°		-135~+80°		-120~+55°	
			-		±180°	
	-163~+242°		-146~+260°		-166~+135°	
	±180°		±360°		±180°	
	±139°		±125°		±135°	±139°
	±360°		±450°		±360°	
	150°/s	185°/s	180°/s	175°/s	170°/s	
	170°/s	180°/s		145°/s	170°/s	
			-		170°/s	
	170°/s	190°/s	180°/s	165°/s	170°/s	
	360°/s	305°/s	255°/s	235°/s	250°/s	360°/s
	360°/s	305°/s	255°/s	235°/s	250°/s	360°/s
	600°/s	420°/s	370°/s	350°/s	300°/s	600°/s
	10kg	35kg	50kg	70kg	20kg	
	-	15kg			-	
	24.5N·m	160N·m	210N·m	300N·m	80.8N·m	49N·m
	24.5N·m	160N·m	210N·m	300N·m	80.8N·m	49N·m
	12N·m	90N·m	130N·m	150N·m	44.1N·m	23.5N·m
	1.6kg·m ²	16kg·m ²	30kg·m ²		6kg·m ²	1.6kg·m ²
	1.6kg·m ²	16kg·m ²	30kg·m ²		6kg·m ²	1.6kg·m ²
	0.7kg·m ²	5kg·m ²	12kg·m ²		2.3kg·m ²	0.8kg·m ²
	2,019mm	2,050mm			1,260mm	1,398mm
	±0.06mm	±0.07mm			±0.06mm	
	0 to 45°C/20 to 85% RH (without condensation)					
	0.5 G or less					
	Floor, inverted mount	Floor mount (OP: inverted, wall, tilted)			Floor, inverted mount	
	IP65 equivalent	Wrist: IP67 equivalent, main body: IP54 equivalent (OP: IP65/67 equivalent)			IP65 equivalent	
	225kg	640kg			230kg	
	1.7kVA	5kVA			1kVA	
	FD11/FD18	FD11/FD18	FD11/FD18	FD11/FD18	FD11/FD18	FD11/FD18
						
	2019	2050			1260	1398

1[N·m]=1/9.8[kgf·m]

LIST OF SPECIFICATIONS

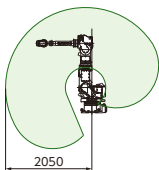
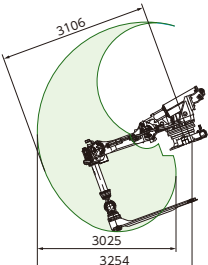
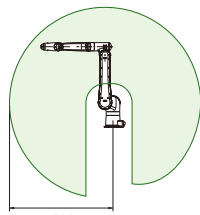
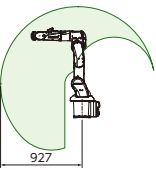
		MR35	MR50	ST210TP-01	CZ10	CMZ05	
							
No. of axes		7		7	6	6	
Max. working envelope	Arm	J1 Swivel 1	$\pm 165^\circ$		$\pm 180^\circ$	$\pm 170^\circ$	$\pm 170^\circ$
		J2 Horizontal	$-120\sim+55^\circ$		$-35\sim+120^\circ$	$-75\sim+225^\circ$	$-135\sim+80^\circ$
		J7 Swivel 2	$\pm 190^\circ$		(Press arm link) $\pm 65^\circ$	–	–
	Wrist	J3 Vertical	$-146\sim+140^\circ$		$-96\sim+210^\circ$	$-77\sim+227^\circ$	$-136\sim+90^\circ$
		J4 Rotation 2	$\pm 360^\circ$		$\pm 360^\circ$	$\pm 180^\circ$	$\pm 190^\circ$
		J5 Bend	$\pm 125^\circ$		$\pm 120^\circ$	$\pm 170^\circ$	$\pm 120^\circ$
	J6 Rotation 1	$\pm 450^\circ$		$\pm 360^\circ$	$\pm 360^\circ$	$\pm 360^\circ$	
Max. speed	Arm	J1 Swivel 1	180° /s	175° /s	110° /s	120° /s	270° /s
		J2 Horizontal	175° /s	140° /s	90° /s	120° /s	245° /s
		J7 Swivel 2	130° /s		(Press arm link) 120° /s	–	–
	Wrist	J3 Vertical	180° /s	165° /s	95° /s	180° /s	310° /s
		J4 Rotation 2	305° /s	255° /s	130° /s	180° /s	550° /s
		J5 Bend	305° /s	255° /s	130° /s	180° /s	550° /s
	J6 Rotation 1	420° /s	370° /s	250° /s	180° /s	950° /s	
Maximum load	Wrist	35kg	50kg	80kg	10kg	5kg	
	Load capacity on forearm*1	15kg		30kg	–	–	
Allowable static load torque for wrist	J4 Rotation 2	160N·m	210N·m	–	25.9N·m	16.9N·m	
	J5 Bend	160N·m	210N·m	–	25.9N·m	16.9N·m	
	J6 Rotation 1	90N·m	130N·m	–	5.9N·m	9.4N·m	
Allowable moment of inertia for wrist	J4 Rotation 2	16kg·m ²	30kg·m ²	J7 axis rotation 80kg·m ²	0.75kg·m ²	0.49kg·m ²	
	J5 Bend	16kg·m ²	30kg·m ²		0.75kg·m ²	0.49kg·m ²	
	J6 Rotation 1	5kg·m ²	12kg·m ²		0.08kg·m ²	0.15kg·m ²	
Maximum reach	2,050mm		3,106mm	1,300mm	927mm		
Pose repeatability	$\pm 0.07\text{mm}$		$\pm 0.3\text{mm}$	$\pm 0.1\text{mm}$	$\pm 0.020\text{mm}$		
Ambient temperature*/humidity	0 to 45°C/20 to 85% RH (without condensation)					0 to 40°C/20 to 85% RH (without condensation)	
Vibration	0.5 G or less						
Installation	Floor mount (OP: inverted, wall, tilted)		Shelf mount (installed at 20° angle)		Floor, inverted mount	Floor	
Ingress protection	IP67 equivalent		–		IP65 equivalent	IP67 equivalent	
Weight	745kg		1,650kg		61kg	53kg	
Power consumption	4.1kVA		7kVA		1kVA	0.8kVA	
Supported Controller	FD11/FD18	FD11/FD18	FD11/FD18		CCZ	CFDs	
Working envelope							

* Maximum speeds are maximum values, they will vary depending on the wrist load conditions and operating program.

*1: This value changes by placement and load conditions of a wrist.

*2: Using at 1,000 m or lower sea level. Ambient temperature has limitations when allowable altitude is exceeded.

1 [N·m] = 1/9.8 [kgf·m]

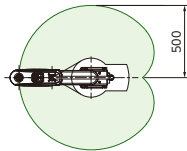
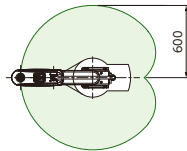
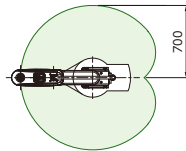
		EC06-5020-01	EC06-6020-01	EC06-7020-01
				
No. of axes		4		
Max. working envelope	J1 Swivel 1	$\pm 140^\circ$		
	J2 Swivel 2	$\pm 150^\circ$		
	J3 Vertical	200mm		
	J4 Rotation	$\pm 360^\circ$		
Max. speed	J1 Swivel 1	$420^\circ /s$		
	J2 Swivel 2	$720^\circ /s$		
	J3 Vertical	1,100mm/s		
	J4 Rotation	$2660^\circ /s$		
Maximum Payload		6kg (3kg rated)		
Allowable moment of inertia for wrist	J4 Rotation	$0.05\text{kg}\cdot\text{m}^2$ ($0.01\text{kg}\cdot\text{m}^2$ rated)		
Maximum reach		500mm	600mm	700mm
Pose repeatability		$\pm 0.02\text{mm}$		
Ambient temperature*1/ humidity		0 to 40°C/20 to 80% RH (without condensation)		
Vibration		0.5 G or less (4.9m/s^2)		
Installation		Floor mount		
Ingress protection		IP20		
Weight		17kg	17kg	18kg
Power consumption		0.5kVA		
Supported Controller		CFD/CFDs	CFD/CFDs	CFD/CFDs
Working envelope				

* Maximum speeds are maximum values, they will vary depending on the wrist load conditions and operating program.
 *1: Using at 1,000 m or lower sea level. Ambient temperature has limitations when allowable altitude is exceeded.

1 [N·m] = 1/9.8 [kgf·m]

LIST OF SPECIFICATIONS

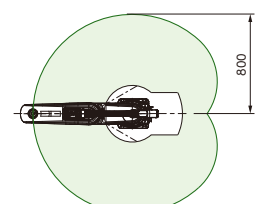
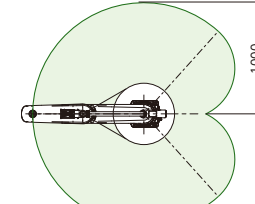
		EC10-8020-01	EC10-8030-01	EC10-A020-01	EC10-A030-01
					
No. of axes		4			
Max. working envelope	J1 Swivel 1	±132°			
	J2 Swivel 2	±150°			
	J3 Vertical	200mm	300mm	200mm	300mm
	J4 Rotation	±360°			
Max. speed	J1 Swivel 1	340° /s		300° /s	
	J2 Swivel 2	630° /s		620° /s	
	J3 Vertical	1,100mm/s			
	J4 Rotation	2,700° /s			
Maximum Payload		10kg (rated 5kg, conditional 12kg)			
Allowable moment of inertia for wrist	J4 Rotation	0.02kg·m ²			
Maximum reach		800mm		1,000mm	
Pose repeatability		±0.025mm			
Ambient temperature*/humidity		5 to 40°C/20 to 80% RH (without condensation)			
Vibration		0.5 G or less			
Installation		Floor mount			
Ingress protection		IP20 equivalent			
Weight		41kg		44kg	
Power consumption		0.8kVA			
Supported Controller		CFDs			
Working envelope					

* Maximum speeds are maximum values, they will vary depending on the wrist load conditions and operating program.
 *1: Using at 1,000 m or lower sea level. Ambient temperature has limitations when allowable altitude is exceeded.

1 [N·m] = 1/9.8 [kgf·m]

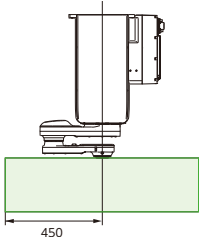
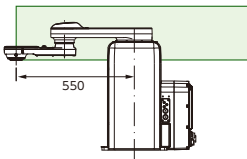
		EZ03V4-04		EZ03F4-04	
					
No. of axes		4			
Max. working envelope	J1	Vertical	250/150mm* ²		
	J2	Swivel 1	±170°		
	J3	Swivel 2	±180°		±145°
	J4	Rotation	±360°		
Max. speed	J1	Vertical	1,400/1,200mm/s* ²		
	J2	Swivel 1	450° /s		
	J3	Swivel 2	720° /s		
	J4	Rotation	2,400° /s		
Maximum Payload		3kg (2kg rated)			
Allowable moment of inertia for wrist	J4	Rotation	0.05kg·m ²		
Maximum reach		450mm		550mm	
Pose repeatability		±0.014mm			
Ambient temperature* ¹ / humidity		0 to 45°C/20 to 85% RH (without condensation)			
Vibration		0.5 G or less (4.9m/s ²)			
Installation		Inverted mount		Floor mount	
Ingress protection		IP20			
Weight		40kg		41kg	
Power consumption		0.6kVA			
Supported Controller		CFD/CFDs		CFD/CFDs	
Working envelope					



* Maximum speeds are maximum values, they will vary depending on the wrist load conditions and operating program.

*1: Using at 1,000 m or lower sea level. Ambient temperature has limitations when allowable altitude is exceeded.

*2: There are two types of maximum operating envelopes: 250 mm and 150 mm. The 250 mm has a maximum speed of 1,400 mm/s. The 150 mm has a maximum speed of 1,200 mm/s.

1 [N·m] = 1/9.8 [kgf·m]

LIST OF SPECIFICATIONS

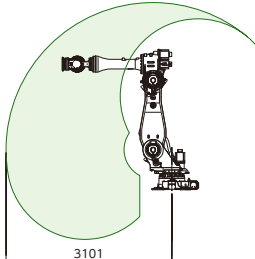
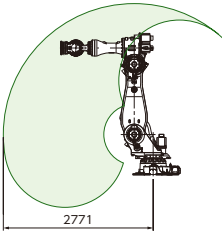
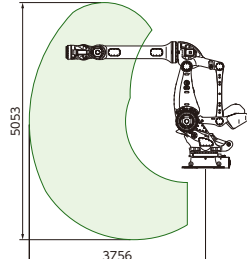
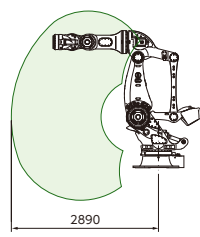
		MC280L	MC350	MC400L	MC600	
						
No. of axes		6				
Max. working envelope	Arm	J1 Swivel 1	±180°			
		J2 Horizontal	-100~+40°	-105~+60°		
		J7 Swivel 2	-			
	Wrist	J3 Vertical	-147~+130°	-180~+130°	-130~+30°	-140~+30°
		J4 Rotation 2	±360°		±210°	
		J5 Bend	±125°		±120°	
Max. speed	Arm	J6 Rotation 1	±360°		±360° *1	
		J1 Swivel 1	105° /s		90° /s	
		J2 Horizontal	105° /s	95° /s	90° /s	
	Wrist	J7 Swivel 2	-			
		J3 Vertical	95° /s		90° /s	
		J4 Rotation 2	120° /s	110° /s		
Maximum load	Wrist	280kg	350kg	400kg	600kg	
	Load capacity on forearm*2	25kg	50kg			
Allowable static load torque for wrist	J4 Rotation 2	1,921N·m	2,750N·m	3,450N·m		
	J5 Bend	1,921N·m	2,750N·m	3,450N·m		
	J6 Rotation 1	988N·m	1,235N·m	1,725N·m		
Allowable moment of inertia for wrist	J4 Rotation 2	400kg·m ²		600kg·m ²		
	J5 Bend	400kg·m ²		600kg·m ²		
	J6 Rotation 1	250kg·m ²		400kg·m ²		
Maximum reach	3,101mm	2,771mm	3,756mm	2,890mm		
Pose repeatability	±0.09mm					
Ambient temperature*3/ humidity	0 to 45°C/20 to 85% RH (without condensation)					
Vibration	0.5 G or less					
Installation	Floor mount					
Ingress protection	-					
Weight	1,660kg	1,620kg	3,400kg	3,300kg		
Power consumption	9kVA	8.6kVA	19.3kVA			
Supported Controller	FD11/FD20	FD11/FD20	FD11/FD20	FD11/FD20		
Working envelope						

*1: The initial settings are ±210°. When passing cable through the hollow part of the 6th axis, use a range of ±210°.

When a cable is not passed through, the operating envelope can be extended to a maximum of ±360°, depending on the usage conditions.

*2: This value changes by placement and load conditions of a wrist.

*3: Using at 1,000 m or lower sea level. Ambient temperature has limitations when allowable altitude is exceeded.

	MC700	MC1000DL	SC700DL
			
		6	
	±180°	±160°	±160°
	-105~+60°	-85~+45°	-85~+45°
		-	
	-140~+30°	-90~+45°	-90~+40°
	±210°	-9.7~+90° (+9.7°)*4	-10~+90°
	±120°	±125°*5	±125°
	±360°*1	±9.7°	±10°
	80°/s	45°/s	45°/s
	80°/s	40°/s	30°/s
		-	
	80°/s	40°/s	30°/s
	100°/s	20°/s*6	30°/s
	100°/s	65°/s	50°/s
	160°/s	70°/s	30°/s
	700kg	1,000kg	700kg
	25kg	-	-
	3,450N·m	21,000N·m	13,800N·m
	3,450N·m	-	3,920N·m
	1,725N·m	4,410N·m	2,940N·m
	600kg·m ²	5,200kg·m ²	3,000kg·m ²
	600kg·m ²	4,000kg·m ²	1,800kg·m ²
	400kg·m ²	1,740kg·m ²	1,000kg·m ²
	2,890mm	3,972mm	3,972mm
	±0.09mm		±0.5mm
	0 to 45°C/20 to 85% RH (without condensation)		
	0.5 G or less		
	Floor mount		
	-		
	3,320kg	9,000kg	7,000kg
	9.3kVA	19kVA	7kVA
	FD11/FD20	FD11	FD11/FD20
			





*4: Max motion range of axis 4 varies due to the wrist payload weight. Wrist load 300 kg < -9.7°~+90°, Wrist load 300 kg ≥ -9.7°~+9.7°

*5: In order to make axis 5 move, axis 4 must be in ±4° from ground level when payload is installed on the wrist.

*6: Axis 4 speed achieves to this value when wrist payload is less than 300 kg and motion range is enough wide.

1 [N·m] = 1/9.8 [kgf·m]

LIST OF SPECIFICATIONS

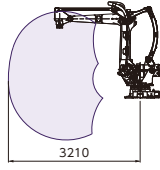
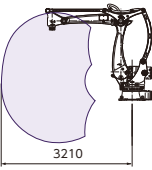
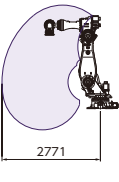
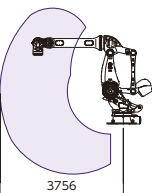



		LP130-01	LP130F	LP180-01	LP210	LPA180-01	MC470P	MC500P	
									
No. of axes		4					6	5	
Max. working envelope	Arm	J1 Swivel 1	±180°				±180°	±180°	
		J2 Horizontal	-95~+41°	-94.5~+40.7°	-95~+41°		-95~+45°	-100~+40°	-105~+60°
		J7 Swivel 2	-				-		
	Wrist	J3 Vertical	-117~+17°	-116.9~+17.2°	-117~+17°		-117.5~+17.5°	-180~+35°	-130~+30°
		J4 Rotation 2	±360°				±360°*1	-	
		J5 Bend	-				±125°*1	±120°	
						±360°			
Max. speed	Arm	J1 Swivel 1	130°/s	145°/s	115°/s	105°/s	140°/s	105°/s	90°/s
		J2 Horizontal	115°/s		100°/s		125°/s	95°/s	90°/s
		J7 Swivel 2	-				-		
	Wrist	J3 Vertical	115°/s		105°/s	100°/s	130°/s	95°/s	90°/s
		J4 Rotation 2	400°/s	535°/s	360°/s	300°/s	400°/s	110°/s	-
		J5 Bend	-				110°/s	110°/s	
		-				180°/s	180°/s		
Maximum load	Wrist	130kg		180kg	210kg	180kg	470kg	500kg	
	Load capacity on forearm*2	25kg				30kg	25kg		
Allowable static load torque for wrist	J4 Rotation 2	-				2,750N·m	-		
	J5 Bend	-				2,750N·m	3,450N·m		
	J6 Rotation 1	-				0N·m	1,725N·m		
Allowable moment of inertia for wrist	J4 Rotation 2	50kg·m ²		69kg·m ²	100kg·m ²	69kg·m ²	400kg·m ²	-	
	J5 Bend	-				400kg·m ²	600kg·m ²		
	J6 Rotation 1	-				250kg·m ²	400kg·m ²		
Maximum reach		3,210mm				2,771mm	3,756mm		
Pose repeatability		±0.09mm							
Ambient temperature*3/ humidity		0 to 45°C/20 to 85% RH (without condensation)							
Vibration		0.5 G or less							
Installation		Floor mount							
Ingress protection		IP50 equivalent	-	IP50 equivalent		-	-		
Weight		1,150kg				1,620kg	3,350kg		
Power consumption		6.2kVA				8.6kVA	9.7kVA		
Supported Controller		FD11/FD18	FD11/FD18	FD11/FD18	FD11/FD18	FD11/FD18	FD11/FD20	FD11	
Working envelope									

*1: Software limits the downward vertical range of axis 5 to ±5°.
Axis 4 can move ±360° and axis 5 can move ±125° only when the encoder correction screen or software limit settings screen is open.

*2: This value changes by placement and load conditions of a wrist.

*3: Using at 1,000 m or lower sea level. Ambient temperature has limitations when allowable altitude is exceeded.

1 [N·m] = 1/9.8 [kgf·m]

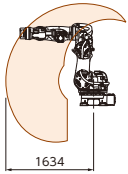
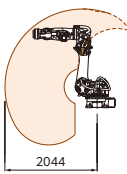
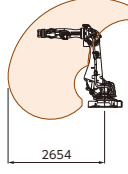
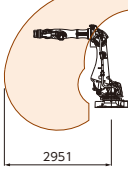





		SRA100HS	SRA100HB	SRA100H	SRA133H	SRA133HL	
							
No. of axes		6					
Max. working envelope	Arm	J1 Swivel 1	±180°		-80~+60°		
		J2 Horizontal	-120~+60°				
		J7 Swivel 2	-				
	Wrist	J3 Vertical	-125~+90°	-151~+90°	-146.5~+150°		-133.4~+150°
		J4 Rotation 2	±210°				
		J5 Bend	±125°				
Max. speed	Arm	J1 Swivel 1	136°/s	125°/s	120°/s	115°/s	
		J2 Horizontal	115°/s		110°/s	105°/s	
		J7 Swivel 2	-				
	Wrist	J3 Vertical	160°/s		121°/s	118°/s	113°/s
		J4 Rotation 2	210°/s	225°/s	210°/s		
		J5 Bend	175°/s				
Maximum load	Wrist	100kg			133kg		
	Load capacity on forearm*1	20kg					
Allowable static load torque for wrist	J4 Rotation 2	830N·m	650N·m	830N·m			
	J5 Bend	830N·m	650N·m	830N·m			
	J6 Rotation 1	441N·m	315N·m	441N·m			
Allowable moment of inertia for wrist	J4 Rotation 2	85kg·m ²					
	J5 Bend	85kg·m ²					
	J6 Rotation 1	45kg·m ²					
Maximum reach	1,634mm	2,044mm	2,654mm		2,951mm		
Pose repeatability	±0.06mm						
Ambient temperature*2/ humidity	0 to 45°C/20 to 85% RH (without condensation)						
Vibration	0.5 G or less						
Installation	Floor mount						
Ingress protection	IP54 equivalent						
Weight	690kg	750kg	1,040kg		1,070kg		
Power consumption	7kVA						
Supported Controller	FD11/FD18/FD20	FD11/FD18/FD20	FD11/FD18/FD20	FD11/FD18/FD20	FD11/FD18/FD20		
Working envelope							

*1: This value changes by placement and load conditions of a wrist.

*2: Using at 1,000 m or lower sea level. Ambient temperature has limitations when allowable altitude is exceeded.

1 [N·m] = 1/9.8 [kgf·m]

LIST OF SPECIFICATIONS

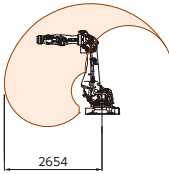
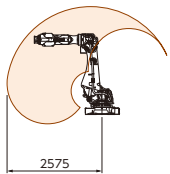
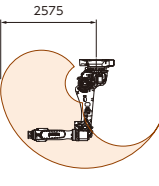
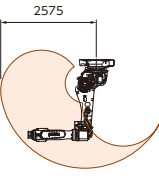
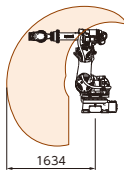
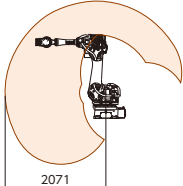
		SRA166H	SRA210H	SRA220H	SRA220HV	SRA100J	SRA100B		
									
No. of axes		6							
Max. working envelope	Arm	J1 Swivel 1	±180°		±165°	±180°	±180°		
		J2 Horizontal	-80~+60°			-120~+60°	-120~+60°		
		J7 Swivel 2	-			-	-		
	Wrist	J3 Vertical	-146.5~+150°	-154~+150°			-125~+90°	-150~+180°	
		J4 Rotation 2	±210°			±360°	±360°		
		J5 Bend	±125°	±130°			±135°	±135°	
	J6 Rotation 1	±210°			±360°	±360°			
Max. speed	Arm	J1 Swivel 1	120° /s	115° /s		136° /s	136° /s		
		J2 Horizontal	110° /s	105° /s		115° /s	110° /s		
		J7 Swivel 2	-			-	-		
	Wrist	J3 Vertical	115° /s	113° /s		160° /s	130° /s		
		J4 Rotation 2	175° /s	130° /s		240° /s	240° /s		
		J5 Bend	171° /s	130° /s		233° /s	233° /s		
	J6 Rotation 1	280° /s	205° /s		351° /s	351° /s			
Maximum load	Wrist	166kg	210kg	220kg		100kg	100kg		
	Load capacity on forearm*1	20kg		20kg/Max.45kg		25kg/Max.45kg	25kg/Max.45kg		
Allowable static load torque for wrist	J4 Rotation 2	960N·m	1337N·m		580N·m	580N·m			
	J5 Bend	960N·m	1337N·m		580N·m	580N·m			
	J6 Rotation 1	520N·m	720N·m		290N·m	290N·m			
Allowable moment of inertia for wrist	J4 Rotation 2	100kg·m ²	200kg·m ²	141.1kg·m ²		45kg·m ²	45kg·m ²		
	J5 Bend	100kg·m ²	200kg·m ²	141.1kg·m ²		45kg·m ²	45kg·m ²		
	J6 Rotation 1	50kg·m ²	155kg·m ²	79kg·m ²		22.7kg·m ²	22.7kg·m ²		
Maximum reach	2,654mm		2,575mm		1,634mm	2,071mm			
Pose repeatability	±0.06mm			±0.15mm		±0.06mm			
Ambient temperature*2/ humidity	0 to 45°C/20 to 85% RH (without condensation)								
Vibration	0.5 G or less								
Installation	Floor mount			Inverted mount		Floor mount			
Ingress protection	IP54 equivalent				Wrist has IP67 and main body has IP54 equivalent				
Weight	1,100kg				670kg	690kg			
Power consumption	7kVA								
Supported Controller	FD11/FD18/FD20	FD11/FD18/FD20	FD11/FD18/FD20	FD11/FD18/FD20	FD11/FD18/FD20	FD11/FD18/FD20	FD11/FD18/FD20		
Working envelope									

*1: This value changes by placement and load conditions of a wrist.

*2: Using at 1,000 m or lower sea level. Ambient temperature has limitations when allowable altitude is exceeded.

*3: Equipped with "A-Trac4" cable support on arm suitable for spot welding.

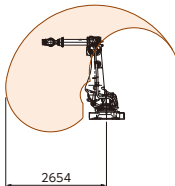
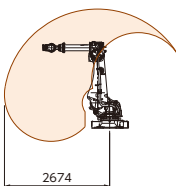
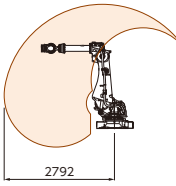
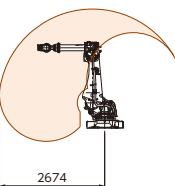

SRA100 (100-01A)*3	SRA166 (166-01A)*3	SRA210 (210-01A)*3	SRA240	SRA250	SRA300
					
6	6			6	
±180°	±180°			±180°	
-80~+60°	-80~+60°			-80~+60°	
-	-			-	
-146.5~+150°	-146.5~+150°			-140~+150°	-146.5~+150°
±360 (±210)°	±360 (±210)°		±360°	±360°	
±135 (±120)°	±135 (±120)°	±130 (±120)°	±130°	±130°	
±360 (±205)°	±360 (±205)°		±360°	±360°	
136° /s	125° /s	115° /s	105° /s	100° /s	105° /s
135° /s	115° /s	105° /s	90° /s		90° /s
-	-			-	
135° /s	121° /s	113° /s	100° /s	95° /s	90° /s
240° /s	180° /s	140° /s	130° /s	125° /s	120° /s
233° /s	173° /s	133° /s	125° /s		120° /s
351° /s	260° /s	200° /s	195° /s	190° /s	200° /s
100kg	166kg	210kg	240kg	250kg	300kg
45kg/Max.90kg (15kg/Max.60kg)			20kg/Max.45kg		25kg/Max.50kg
580N·m	951N·m	1,337N·m		1,830N·m	
580N·m	951N·m	1,337N·m		1,830N·m	
290N·m	490N·m	720N·m		930N·m	
60kg·m ²	88.9kg·m ²	141.1kg·m ²		225.4kg·m ²	330kg·m ²
60kg·m ²	88.9kg·m ²	141.1kg·m ²		225.4kg·m ²	330kg·m ²
30kg·m ²	45kg·m ²	79kg·m ²		196kg·m ²	240kg·m ²
2,654mm	2,654mm	2,674mm		2,792mm	2,674mm
±0.06mm					±0.1mm
0 to 45°C/20 to 85% RH (without condensation)					
0.5 G or less					
Floor mount					
Wrist has IP67 and main body has IP54 equivalent					
960 (1,060)kg		990 (1,090)kg	990kg	1,030kg	1,170kg
7kVA					8.1kVA
FD11/FD18/FD20	FD11/FD18/FD20	FD11/FD18/FD20	FD11/FD18/FD20	FD11/FD18/FD20	FD20
					

1 [N·m] = 1/9.8 [kgf·m]

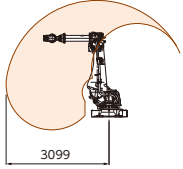
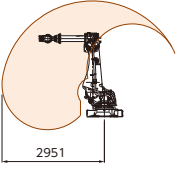
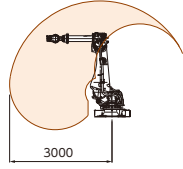
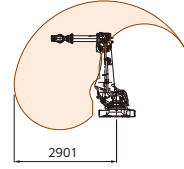
LIST OF SPECIFICATIONS

		SRA120EL	SRA133L	SRA166L	SRA210L	SRA240L	
							
No. of axes		6			6		
Max. working envelope	Arm	J1 Swivel 1	±180°			±180°	
		J2 Horizontal	-80~+60°			-80~+60°	
		J7 Swivel 2	-			-	
	Wrist	J3 Vertical	-127.7~+150°	-133.4~+150°		-132.4~+150°	-135.8~+150°
		J4 Rotation 2	±360°			±360°	
		J5 Bend	±135°			±130°	
Max. speed	Arm	J1 Swivel 1	115°/s	125°/s	115°/s	100°/s	
		J2 Horizontal	105°/s	115°/s	105°/s	90°/s	
		J7 Swivel 2	-			-	
	Wrist	J3 Vertical	113°/s	121°/s	113°/s	95°/s	
		J4 Rotation 2	140°/s			125°/s	
		J5 Bend	173°/s			125°/s	
Maximum load	Wrist	120kg	133kg	166kg	210kg	240kg	
	Load capacity on forearm*1	45kg/Max.90kg			20kg		
Allowable static load torque for wrist	J4 Rotation 2	687N·m	800N·m	951N·m	1,000N·m	1,140N·m	
	J5 Bend	687N·m	800N·m	951N·m	1,000N·m	1,140N·m	
	J6 Rotation 1	353N·m	400N·m	490N·m	720N·m	720N·m	
Allowable moment of inertia for wrist	J4 Rotation 2	60kg·m ²	76kg·m ²	88.9kg·m ²	141.1kg·m ²		
	J5 Bend	60kg·m ²	76kg·m ²	88.9kg·m ²	141.1kg·m ²		
	J6 Rotation 1	30kg·m ²	38kg·m ²	45kg·m ²	79kg·m ²		
Maximum reach	3,099mm	2,951mm		3,000mm	2,901mm		
Pose repeatability	±0.06mm			±0.08mm			
Ambient temperature*2/ humidity	0 to 45°C/20 to 85% RH (without condensation)						
Vibration	0.5 G or less						
Installation	Floor mount						
Ingress protection	Wrist has IP67 and main body has IP54 equivalent						
Weight	985kg	980kg		1,050kg			
Power consumption	7kVA						
Supported Controller	FD11/FD18/FD20	FD11/FD18/FD20	FD11/FD18/FD20	FD11/FD18/FD20			
Working envelope							

*1: This value changes by placement and load conditions of a wrist.
 *2: Using at 1,000 m or lower sea level. Ambient temperature has limitations when allowable altitude is exceeded.
 *3: Equipped with "A-Trac4" cable support on arm suitable for spot welding.

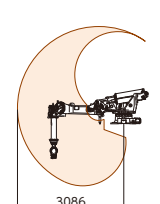
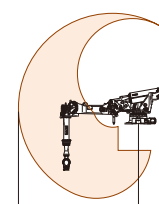
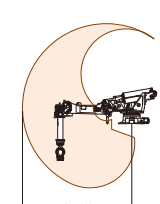
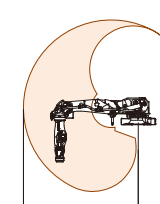
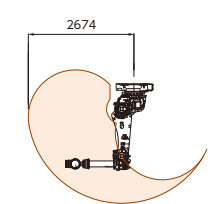
SRA166T (166T-01A)*3	SRA166TL	SRA210T (210T-01A)*3	SRA166HT	SRA210HT	SRA210V
					
6			6		6
±180°			±180°		±165°
-65~+120°			-65~+120°		-80~+60°
-			-		-
-106~+210°	-90~+210°	-106~+210°	-112~+210°		-146.5~+150°
±360 (±210)°	±360°	±360 (±210)°	±210°		±360°
±135 (±120)°	±135°	±130 (±120)°	±125°		±130°
±360 (±205)°			±210°		±360°
110° /s	105° /s	100° /s	120° /s	115° /s	115° /s
110° /s	90° /s		110° /s	105° /s	105° /s
-			-		-
115° /s		100° /s	115° /s	113° /s	113° /s
180° /s	140° /s	140° /s	175° /s	130° /s	140° /s
173° /s		133° /s	171° /s	130° /s	133° /s
260° /s		200° /s	280° /s	205° /s	200° /s
166kg		210kg	166kg	210kg	210kg
45kg/Max.90kg (15kg/Max.60kg)			20kg		45kg/Max.90kg
951N·m		1,337N·m	960N·m	1,337N·m	1,337N·m
951N·m		1,337N·m	960N·m	1,337N·m	1,337N·m
490N·m		720N·m	520N·m	720N·m	720N·m
88.9kg·m ²		141.1kg·m ²	100kg·m ²	200kg·m ²	141.1kg·m ²
88.9kg·m ²		141.1kg·m ²	100kg·m ²	200kg·m ²	141.1kg·m ²
45kg·m ²		79kg·m ²	50kg·m ²	155kg·m ²	79kg·m ²
3,086mm	3,383mm	3,106mm	3,087mm		2,674mm
±0.08mm			±0.08mm		±0.15mm
0 to 45°C/20 to 85% RH (without condensation)					
0.5 G or less					
Shelf mount					Inverted mount
Wrist has IP67 and main body has IP54 equivalent			IP54 equivalent		Wrist has IP67 and main body has IP54 equivalent
1,210 (1,310)kg	1,240kg	1,250 (1,350)kg	1,160kg		990kg
7kVA					
FD11/FD18/FD20	FD11/FD18/FD20	FD11/FD18/FD20	FD11/FD18/FD20	FD11/FD18/FD20	FD11/FD18/FD20
					

1 [N·m] = 1/9.8 [kgf·m]

LIST OF SPECIFICATIONS

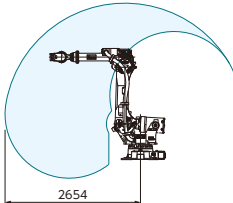
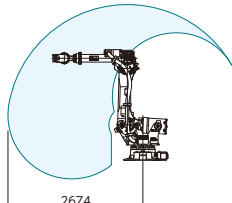
		ST133CF	ST166CF	ST210CF	
					
No. of axes		6			
Max. working envelope	Arm	J1 Swivel 1	$\pm 165^\circ$		
		J2 Horizontal	$-80 \sim +60^\circ$		
		J7 Swivel 2	-		
	Wrist	J3 Vertical	$-137 \sim +150^\circ$		
		J4 Rotation 2	$\pm 360^\circ$		
		J5 Bend	$\pm 135^\circ$	$\pm 130^\circ$	
Max. speed	Arm	J1 Swivel 1	$130^\circ / s$	$110^\circ / s$	$100^\circ / s$
		J2 Horizontal	$130^\circ / s$	$110^\circ / s$	$90^\circ / s$
		J7 Swivel 2	-		
	Wrist	J3 Vertical	$130^\circ / s$	$110^\circ / s$	$95^\circ / s$
		J4 Rotation 2	$230^\circ / s$	$170^\circ / s$	$130^\circ / s$
		J5 Bend	$230^\circ / s$	$170^\circ / s$	$130^\circ / s$
Maximum load	Wrist	133kg	166kg	210kg	
	Load capacity on forearm*1	70kg			
Allowable static load torque for wrist	J4 Rotation 2	$745N \cdot m$	$951N \cdot m$	$1,337N \cdot m$	
	J5 Bend	$745N \cdot m$	$951N \cdot m$	$1,337N \cdot m$	
	J6 Rotation 1	$411N \cdot m$	$490N \cdot m$	$720N \cdot m$	
Allowable moment of inertia for wrist	J4 Rotation 2	$60.9kg \cdot m^2$	$88.9kg \cdot m^2$	$141.1kg \cdot m^2$	
	J5 Bend	$60.9kg \cdot m^2$	$88.9kg \cdot m^2$	$141.1kg \cdot m^2$	
	J6 Rotation 1	$30.2kg \cdot m^2$	$45kg \cdot m^2$	$79kg \cdot m^2$	
Maximum reach	2,654mm		2,674mm		
Pose repeatability	$\pm 0.06mm$				
Ambient temperature*2/ humidity	10 to 45°C/20 to 85% RH (without condensation)				
Vibration	0.5 G or less				
Installation	Floor mount				
Ingress protection	-				
Weight	1,120kg		1,160kg		
Power consumption	4.2kVA				
Clean rating*3	Class 6				
Supported Controller	FD11/FD18	FD11/FD18		FD11/FD18	
Working envelope					

*1: This value changes by placement and load conditions of a wrist.

*2: Using at 1,000 m or lower sea level. Ambient temperature has limitations when allowable altitude is exceeded.

*3: Clean rating complies with ISO 14644-1

1 [N·m] = 1/9.8 [kgf·m]

SUPPORT SOFTWARE/FEATURES

Easier to use from introduction, to maintenance, various functions such as PC software and software PLC can be programmed and simulations are prepared.

FD on Desk II (Programming PC software)

Simulation and offline programming product for NACHI robots

- FD on Desk II Pro Options
- FD on Desk II Regular Options
- FD on Desk II Light Standard *CFD controller only

Grade	Pro		Regular		Light	Trial version (Demo Licence)
Type No.	FDONDESK2-PRO	FDONDESK2-PRO-D	FDONDESK2-REG	FDONDESK2-REG-D	-	-
Licence certification	Licence file	USB dongle	Licence file	USB dongle	Actual Robot Controller required	ASK
CFD	Offline mode	○	○	○	○	△
	Monitor mode	○	○	○	○	×
	View mode	○	○	○	○	×
FD	Offline mode	○	○	○	△	△
	Monitor mode	○	○	○	△	×
	View mode	○	○	○	△	×
Program generation function from CAD	○	○	×	×	×	×
Multiple controller operation	○	○	×	×	×	×
Save shape file	○	○	○	○	○	×

○ : Usableness
 △ : Enable to use in operator level BEGINNER. (Applied to MZ, ES and EZ)
 × : Unusableness

FD on Desk III (Programming PC software)

Options

PC software that makes it easy and smooth for robot applications with programming and simulation functions

Compatible controller: FD/CFD/CFDs/CFDq/FD18/FD20

- Supports reading of large-scale files such as peripheral devices.
- Visual programming

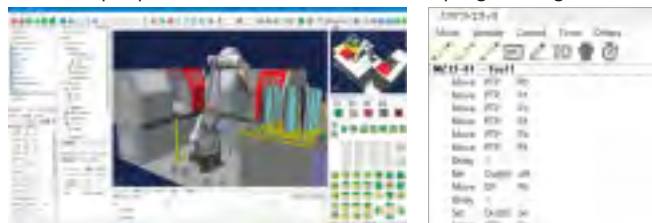

- High performance interference surveillance, video output function, etc.

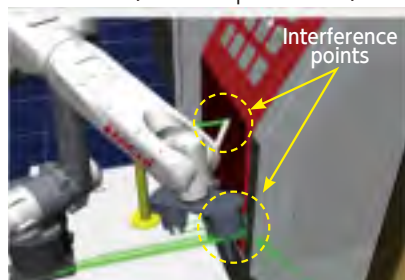

User task functions

Standard

Possible to program processes in parallel with robot operations

- Time consuming calculations and robot operations are processed in parallel to reduce cycle times
- Various statuses are shown on the screen on the teach pendant

Robot Monitoring Unit RMU

Options

- Safety control unit monitors robot conditions (position and speed)
- Possible to reduce costs and space
- Facilities are safer because the positions and speeds of robots are monitored
- Limit working envelope of robot
- Minimize size of safety fences

Working envelope of robot and safety fence

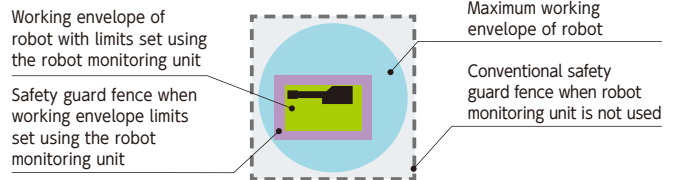

FD-ST easy

Options

PC software that can teach robot operation programs and simulate operation program on a PC.

- Automatic path generation function specifies edges on the workpiece and automatically generate teaching points for robot to work with.
- Provides an advanced 3D Viewer for importing complex data, viewing scene graphs, and drawing in high definition

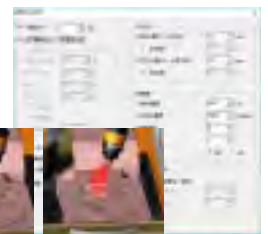

Software PLC

Standard

Incorporated PLC functionality into robot control software

- Eliminates the necessity of external PLC and reduces equipment costs
- Programming is also possible on teach pendant

OpenNR-IF

Options

Users can create their own application software to connect to the FD controller and external devices (cameras, etc.).

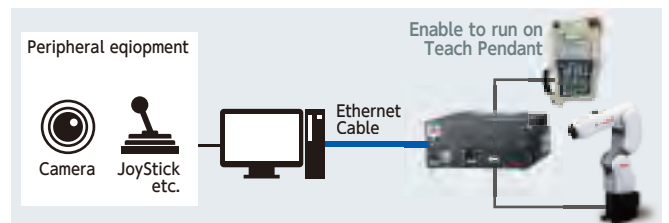

Monitoring function of robot operation

- Indication of robot move command
- Acquisition of robot status (Input/output signals, Variables, Shift Values)

SUPPORT SYSTEMS

Robot systems

System products

NACHI's system engineering team puts its wealth of experience to work for you, providing system solutions that are easy to use along with high-cost performance.

Peripheral devices for the robot

NACHI provides proven highly-reliable robot application devices.

Offline program system

Robot operations can be simulated before installation to check performance. Creating an operation program beforehand allows the robot to be directly installed in the assembly line.



Post-installation service

From setup through startup

NACHI's skilled technicians provide support during the installation process, from setup to connection, teaching, movement, and supervision, until the line is fully operational.

Quick response to emergency calls

NACHI's specialized technicians are "on-call" to immediately respond to customer emergencies.

Reliable support from remote locations

Robots can be operated remotely when placed online, allowing specialized service professionals to provide accurate support to worldwide locations.

The right parts when you need them

Our service locations always have important maintenance parts in stock. We can deliver the parts you need quickly.

Periodic inspections

As a trusted and reliable partner, NACHI performs periodic inspections to extend the life of your robot.

Overhauls

NACHI provides a selection of services suited to the conditions of your robot and performs overhauls to ensure that your robot is always in the best condition. NACHI can also provide temporary replacement robots to keep your line operating during repairs.



Overhauls

Training

Robot training course

Fully utilize your Nachi robots, we have robot training classes which use our own curriculum to teach the basics of operating and maintaining robots.

We support a wide range of robots from compact MZ series to large robots and offer training classes tailored to your needs. We will flexibly comply to your request, please feel free to contact us.



NR: connect

Software enables to collection of robot operation data and visualizations.

BY connecting robots to NR: connect, it is possible to collect, visualize operational status data and improve maintainability.

Data Collector (Robot data collection software) Options

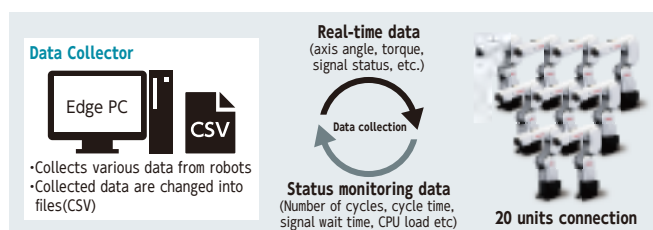

- Constantly monitor the error status of robot controller and automatically save the status when an error occurs
- The output data can be imported to the customer's core system, etc.

Smart Monitor (robot data monitoring software) Options

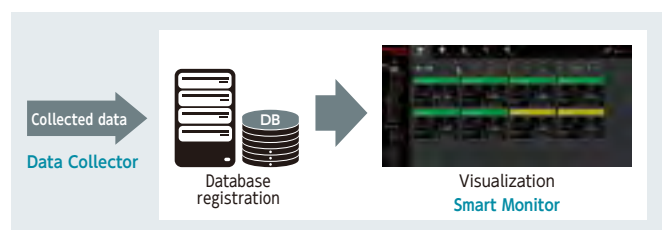

- Display the data collected by Data Collector clearly on a screen
- Intuitive UI gives you easy access to the information you need so that robot operation status can be checked in real-time.
- When an error occurs, the operating status before and after the error is displayed graphically and makes it easy to understand the situation before and after the error.

WORLD SERVICE NETWORK

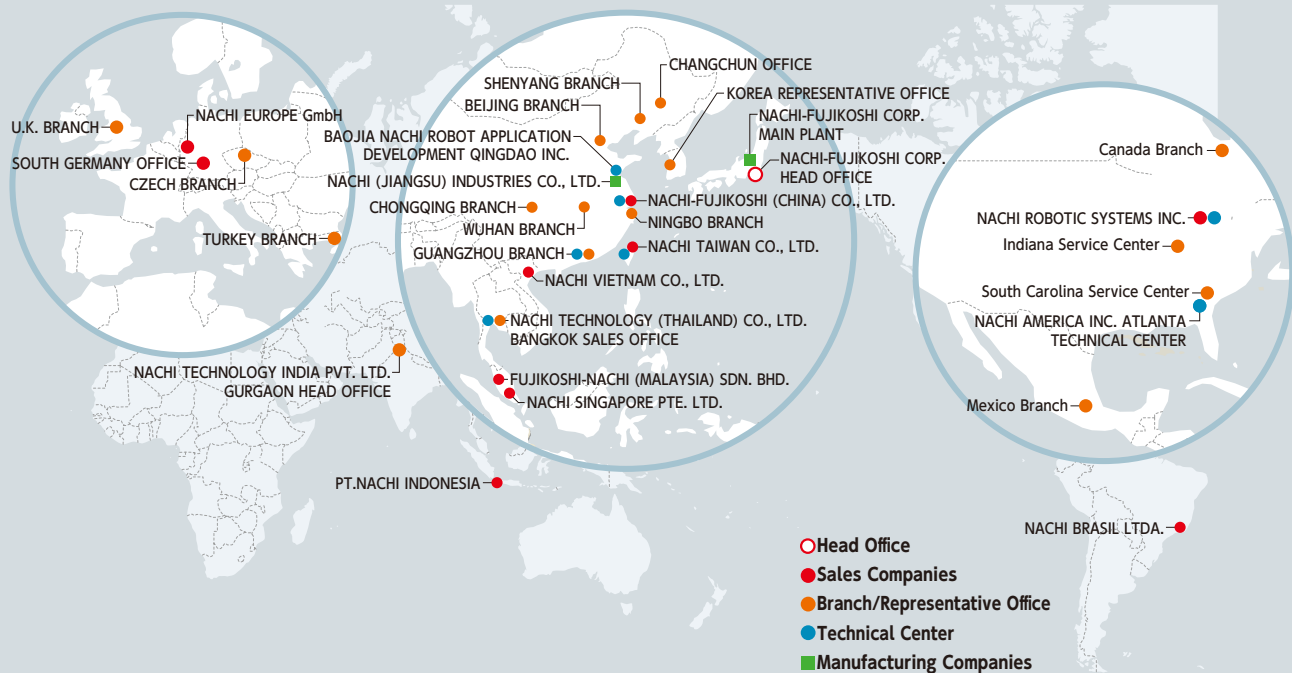
**NACHI-FUJIKOSHI CORP.** <http://www.nachi.com>**Head Office**

Shiodome Sumitomo Bldg.17F, 1-9-2 Higashi-Shinbashi, Minato-ku, Tokyo 105-0021
Tel: +81-(0)3-5568-5111 Fax: +81-(0)3-5568-5206

Robot division

1-1-1 Fujikoshi-Honmachi, Toyama 930-8511, JAPAN
Tel: +81-(0)76-456-2223 Fax: +81-(0)76-493-5252

Overseas subsidiaries**AMERICA****NACHI ROBOTIC SYSTEMS INC.**

46200 W. 12 Mile Rd. Novi, Michigan 48377, U.S.A.
Tel: +1-248-305-6545 Fax: +1-248-305-6542
URL: <http://www.nachirobotics.com/>

Indiana Service Center

715 Pushville Road, Greenwood, Indiana, 46143, U.S.A.
Tel: +1-502-517-1553 Fax: +1-317-535-3659

South Carolina Service Center

1310 Garlington Road, Suite L, Greenville, SC 29615, U.S.A.
Tel: +1-864-458-8000 Fax: +1-864-458-8256

Canada Branch

89 Courtland Ave., Unit No.2, Concord, Ontario, L4K 3T4, CANADA
Tel: +1-905-760-9542 Fax: +1-905-760-9477

Mexico Branch

Av. 100 Metros No.1112-A Nueva Industrial Vallejo Gustavo A. Madero, Ciudad de Mexico C.P. 07700, MEXICO
Tel: +52-55-5312-6556 Fax: +52-55-5312-7248

NACHI AMERICA INC. ATLANTA TECHNICAL CENTER

1950 Evergreen Blvd. Duluth, GA 30096, U.S.A.
Tel: +1-877-622-4487
URL: <http://www.nachiamerica.com/>

NACHI BRASIL LTDA. SAO PAULO BRANCH

Av. Paulista, 453, Primeiro Andar, Conj. 11, 12, 13 e 14, Cerqueira Cesar, São Paulo-SP, CEP : 01311-000, BRASIL
Tel: +55-11-3284-9844 Fax: +55-11-3284-1751
URL: <https://www.nachi.com.br/>

EUROPE**NACHI EUROPE GmbH**

Bischofstrasse 99, 47809, Krefeld, GERMANY
Tel: +49-(0)2151-65046-0 Fax: +49-(0)2151-65046-90
URL: <http://www.nachi.de/>

SOUTH GERMANY OFFICE

Pleidelsheimer Str.47, 74321, Bietigheim-Bissingen, GERMANY
Tel: +49-(0)7142-77418-0 Fax: +49-(0)7142-77418-20

U.K. BRANCH

Unit 3, 92, Kettles Wood Drive, Woodgate Business Park BIRMINGHAM B32 3DB, U.K.
Tel: +44-(0)121-423-5000 Fax: +44-(0)121-421-7520

CZECH BRANCH

Obchodni 132, Cestlice 251 01, Czech Republic
Tel: +420-(0)255-734-000 Fax: +420-(0)255-734-001

TURKEY BRANCH

Ataturk Mah. Mustafa Kemal Cad. No: 10/1A. 34758 Atasehir / Istanbul, TURKEY
Tel: +90-(0)216-688-4457 Fax: +90-(0)216-688-4458

ASIA**不二越 (中国) 有限公司****NACHI-FUJIKOSHI (CHINA) CO., LTD.**

5F, Building A, National Center for Exhibition and Convention, 1988 Zhuguang Road, Qingspu District, Shanghai, 201702, CHINA
Tel: +86-(0)21-6915-2200 Fax: +86-(0)21-6915-5427

NACHI TECHNOLOGY (THAILAND) CO., LTD. BANGKOK SALES OFFICE

Unit 23/109(A), Fl.24th Sorachai Bldg., Sukhumvit 63 Road(Ekamai), Klongtonnu, Wattana, Bangkok 10110, THAILAND
Tel: +66-2-714-0008 Fax: +66-2-714-0740

ROBOT TECHNICAL CENTER

170/2 (1st floor) Ocean Tower 1 Soi Sukhumvit 16, Ratchadaphisek Rd., Klongtoey, Klongtoey, Bangkok 10110, THAILAND
Tel: +66-2-250-4101 Fax: +66-2-258-4103

NACHI SINGAPORE PTE. LTD.

No.2 Joo Koon Way, Jurong Town, Singapore 628943, SINGAPORE
Tel: +65-65587393 Fax: +65-65587371

NACHI VIETNAM CO., LTD.

1502B, 15floor, Lot A1 Indochina Plaza Hanoi, 241 Xuan Thuy Street, Dich Vong Hau ward, Cau Giay dist, Ha Noi city, VIETNAM
Tel: +84-24-3767-8605 Fax: +84-24-3767-8604

FUJIKOSHI-NACHI (MALAYSIA) SDN. BHD.

No.17, Jalan USJ 21/3, 47630 UEP Subang Jaya, Selangor Darul Ehsan, MALAYSIA
Tel: +60-(0)3-80247900 Fax: +60-(0)3-80235884

PT.NACHI INDONESIA

Tempo Scan Tower, 31st Floor JL.H.R Rasuna Said Kav. 3-4, Kuningan, Jakarta 12950, INDONESIA
Tel: +62-021-527-2841 Fax: +62-021-527-3029

NACHI TECHNOLOGY INDIA PVT. LTD. GURGAON HEAD OFFICE

Unit No. 108, 1st Floor, Sewa Corporate Park, M. G Road, Gurgaon-122002, Haryana, INDIA
Tel: +91-(0)12-4450-2900 Fax: +91-(0)12-4450-2910

台灣那智不二越股份有限公司**NACHI TAIWAN CO.,LTD.**

2F, No 23, Lane 15, Sec. 6, Minquan E. Rd., Neihu Dist., Taipei City, TAIWAN
Tel: +886-(0)2-27921895

NACHI-FUJIKOSHI CORP. KOREA REPRESENTATIVE OFFICE

8F, Chan & Chan Tower, 77-9, Samseong-dong, Gangnam-gu, Seoul, 06087, KOREA
Tel: +82-(0)2-6929-2292 Fax: +82-(0)2-6929-2293



Safety precautions

- Before using any robot, review all documentation including operating instructions and other attached documents. Familiarize yourself with the contents in order to ensure proper robot operation.
- When a robot is to be used for an application where robot operation may directly threaten the life or cause physical harm to personnel, a careful examination of its intended use is required. Contact a NACHI-FUJIKOSHI sales representative to provide details of the intended use. Obtain proper training prior to operating robot.
- Photos used in this document show the robots without safety fences, equipment, and devices that are required to comply with the applicable laws and regulations for ensuring safety. These photos are only provided to illustrate what is being described.
- The external appearances, specifications, etc. of the products portrayed in this catalog are subject to change without notice due to improvements in performance.

CATALOG NO.	R7001E-23
--------------------	------------------

2023.11.X-MD-ABE